



marantz®

Model SR3001 User Guide

AV Surround Receiver

	CAUTION RISK OF ELECTRIC SHOCK DO NOT OPEN	
CAUTION: TO REDUCE THE RISK OF ELECTRIC SHOCK, DO NOT REMOVE COVER (OR BACK) NO USER-SERVICEABLE PARTS INSIDE REFER SERVICING TO QUALIFIED SERVICE PERSONNEL		

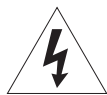

The lightning flash with arrowhead symbol within an equilateral triangle is intended to alert the user to the presence of uninsulated "dangerous voltage" within the product's enclosure that may be of sufficient magnitude to constitute a risk of electric shock to persons.



The exclamation point within an equilateral triangle is intended to alert the user to the presence of important operating and maintenance (servicing) instructions in the literature accompanying the product.

WARNING

**TO REDUCE THE RISK OF FIRE OR ELECTRIC SHOCK,
DO NOT EXPOSE THIS APPLIANCE TO RAIN OR MOISTURE.**

**CAUTION: TO PREVENT ELECTRIC SHOCK, MATCH WIDE BLADE OF PLUG
TO WIDE SLOT, FULLY INSERT.**

**ATTENTION: POUR ÉVITER LES CHOCS ÉLECTRIQUES, INTRODUIRE LA
LAME LA PLUS LARGE DE LA FICHE DANS LA BORNE CORRESPONDANTE
DE LA PRISE ET POUSSER JUSQU'AU FOND.**

NOTE TO CATV SYSTEM INSTALLER:

This reminder is provided to call the CATV (Cable-TV) system installer's attention to Section 820-40 of the NEC which provides guidelines for proper grounding and, in particular, specifies that the cable ground shall be connected to the grounding system of the building, as close to the point of cable entry as practical.

NOTE:

This equipment has been tested and found to comply with the limits for a Class B digital device, pursuant to Part 15 of the FCC Rules. These limits are designed to provide reasonable protection against harmful interference in a residential installation. This equipment generates, uses and can radiate radio frequency energy and, if not installed and used in accordance with the instructions, may cause harmful interference to radio communications. However, there is no guarantee that interference will not occur in a particular installation. If this equipment does cause harmful interference to radio or television reception, which can be determined by tuning the equipment off and on, the user

is encouraged to try to correct the interference by one or more of the following measures:

- Reorient or relocate the receiving antenna.
- Increase the separation between the equipment and receiver.
- Connect the equipment into an outlet on a circuit different from that to which the receiver is connected.
- Consult the dealer or an experienced radio/TV technician for help.

NOTE:

Changes or modifications not expressly approved by the party responsible for compliance could void the user's authority to operate the equipment.

IMPORTANT SAFETY INSTRUCTIONS

READ BEFORE OPERATING EQUIPMENT

This product was designed and manufactured to meet strict quality and safety standards. There are, however, some installation and operation precautions which you should be particularly aware of.

1. Read Instructions – All the safety and operating instructions should be read before the product is operated.
2. Retain Instructions – The safety and operating instructions should be retained for future reference.
3. Heed Warnings – All warnings on the product and in the operating instructions should be adhered to.
4. Follow Instructions – All operating and use instructions should be followed.
5. Cleaning – Unplug this product from the wall outlet before cleaning. Do not use liquid cleaners or aerosol cleaners. Use a damp cloth for cleaning.
6. Attachments – Do not use attachments not recommended by the product manufacturer as they may cause hazards.
7. Water and Moisture – Do not use this product near water-for example, near a bath tub, wash bowl, kitchen sink, or laundry tub, in a wet basement, or near a swimming pool, and the like.
8. Accessories – Do not place this product on an unstable cart, stand, tripod, bracket, or table. The product may fall, causing serious injury to a child or adult, and serious damage to the product. Use only with a cart, stand, tripod, bracket, or table recommended by the manufacturer, or sold with the product. Any mounting of the product should follow the manufacturer's instructions, and should use a mounting accessory recommended by the manufacturer.

9. A product and cart combination should be moved with care. Quick stops, excessive force, and uneven surfaces may cause the product and cart combination to overturn.



10. Ventilation – Slots and openings in the cabinet are provided for ventilation and to ensure reliable operation of the product and to protect it from overheating, and these openings must not be blocked or covered. The openings should never be blocked by placing the product on a bed, sofa, rug, or other similar surface. This product should not be placed in a built-in installation such as a bookcase or rack unless proper ventilation is provided or the manufacturer's instructions have been adhered to.
11. Power Sources – This product should be operated only from the type of power source indicated on the marking label. If you are not sure of the type of power supply to your home, consult your product dealer or local power company. For products intended to operate from battery power, or other sources, refer to the operating instructions.

12. Grounding or Polarization – This product may be equipped with a polarized alternating current line plug (a plug having one blade wider than the other). This plug will fit into the power outlet only one way. This is a safety feature. If you are unable to insert the plug fully into the outlet, try reversing the plug. If the plug should still fail to fit, contact your electrician to replace your obsolete outlet. Do not defeat the safety purpose of the polarized plug.

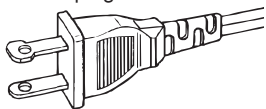

AC POLARIZED PLUG

13. Power-Cord Protection – Power-supply cords should be routed so that they are not likely to be walked on or pinched by items placed upon or against them, paying particular attention to cords at plugs, convenience receptacles, and the point where they exit from the product.
14. Protective Attachment Plug – The product is equipped with an attachment plug having overload protection. This is a safety feature. See Instruction Manual for replacement or resetting of protective device. If replacement of the plug is required, be sure the service technician has used a replacement plug specified by the manufacturer that has the same overload protection as the original plug.
15. Outdoor Antenna Grounding – If an outside antenna or cable system is connected to the product, be sure the antenna or cable system is grounded so as to provide some protection against voltage surges and built-up static charges. Article 810 of the National Electrical Code, ANSI/NFPA 70, provides information with regard to proper grounding of the mast and supporting structure, grounding of the lead-in wire to an antenna-discharge unit, size of grounding conductors, location of antenna-discharge unit, connection to grounding electrodes, and requirements for the grounding electrode. See Figure 1.

16. Lightning – For added protection for this product during a lightning storm, or when it is left unattended and unused for long periods of time, unplug it from the wall outlet and disconnect the antenna or cable system. This will prevent damage to the product due to lightning and power-line surges.
17. Power Lines – An outside antenna system should not be located in the vicinity of overhead power lines or other electric light or power circuits, or where it can fall into such power lines or circuits. When installing an outside antenna system, extreme care should be taken to keep from touching such power lines or circuits as contact with them might be fatal.
18. Overloading – Do not overload wall outlets, extension cords, or integral convenience receptacles as this can result in a risk of fire or electric shock.
19. Object and Liquid Entry – Never push objects of any kind into this product through openings as they may touch dangerous voltage points or short-out parts that could result in a fire or electric shock. Never spill liquid of any kind on the product.
20. Servicing – Do not attempt to service this product yourself as opening or removing covers may expose you to dangerous voltage or other hazards. Refer all servicing to qualified service personnel.
21. Damage Requiring Service – Unplug this product from the wall outlet and refer servicing to qualified service personnel under the following conditions:
- When the power-supply cord or plug is damaged.
 - If liquid has been spilled, or objects have fallen into the product.
 - If the product has been exposed to rain or water.

- If the product does not operate normally by following the operating instructions. Adjust only those controls that are covered by the operating instructions as an improper adjustment of other controls may result in damage and will often require extensive work by a qualified technician to restore the product to its normal operation.
- If the product has been dropped or damaged in any way, and
- When the product exhibits a distinct change in performance this indicates a need for service.

22. Replacement Parts – When replacement parts are required, be sure the service technician has used replacement parts specified by the manufacturer or have the same characteristics as the original part. Unauthorized substitutions may result in fire, electric shock, or other hazards.
23. Safety Check – Upon completion of any service or repairs to this product, ask the service technician to perform safety checks to determine that the product is in proper operating condition.
24. Wall or Ceiling Mounting – The product should be mounted to a wall or ceiling only as recommended by the manufacturer.
25. Heat – The product should be situated away from heat sources such as radiators, heat registers, stoves, or other products (including amplifiers) that produce heat.

FIGURE 1
EXAMPLE OF ANTENNA GROUNDING AS PER
NATIONAL ELECTRICAL CODE, ANSI/NFPA 70

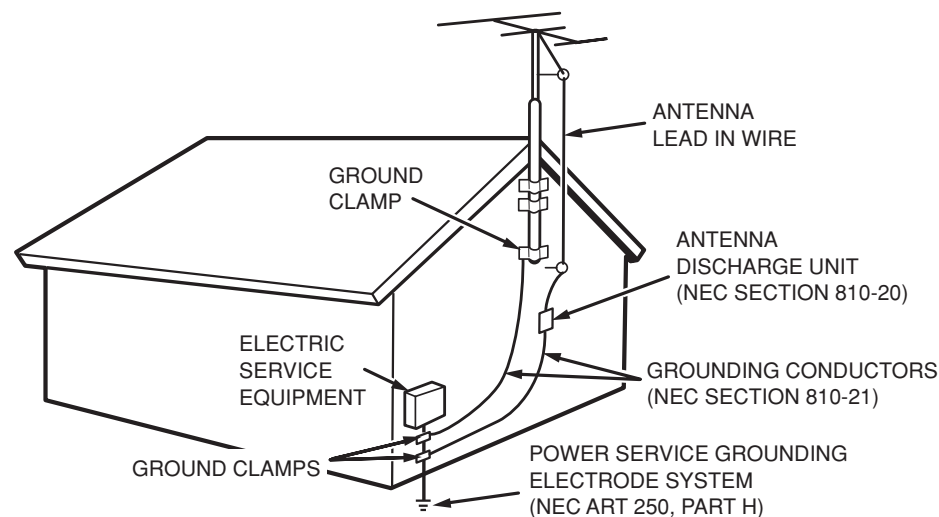

NEC - NATIONAL ELECTRICAL CODE

TABLE OF CONTENTS

FOREWORD.....1

INTRODUCTION1

PRECAUTIONS.....1

DESCRIPTION2

FEATURES.....3

ACCESSORIES.....3

FRONT PANEL4

 FL DISPLAY5

REAR PANEL6

REMOTE CONTROL OPERATION7

 FUNCTION AND OPERATION7

 PROGRAMMING THE REMOTE CONTROLLER8

 OPERATION OF REMOTE CONTROL UNIT9

 GENERAL INFORMATION OF RC5500SR TO SR30019

CONNECTIONS11

 SPEAKER PLACEMENT11

 CONNECTING SPEAKERS.....11

 CONNECTING AUDIO COMPONENTS.....12

 CONNECTING VIDEO COMPONENTS.....13

 ADVANCED CONNECTING14

 CONNECTING THE REMOTE CONTROL JACKS.....14

 CONNECTING THE ANTENNA TERMINALS15

SETUP16

 SETUP MENU SYSTEM16

 ENTER THE DESIRED MENU ITEM

 OF THE SETUP MENU16

 SIMPLE SETUP.....17

 1. INPUT SETUP (ASSIGNABLE DIGITAL INPUT)17

 2. SPEAKER SETUP.....18

 3. PREFERENCE21

 4. SURROUND21

 5. PL II (DOLBY PRO LOGIC II) MUSIC PARAMETER.....22

 6. CS II (CIRCLE SURROUND II)22

BASIC OPERATION (PLAY BACK).....23

 SELECTING AN INPUT SOURCE.....23

 SELECTING THE SURROUND MODE.....23

 ADJUSTING THE MAIN VOLUME23

 ADJUSTING THE TONE (BASS & TREBLE) CONTROL23

 TEMPORARILY TURNING OFF THE SOUND23

 USING THE SLEEP TIMER23

 NIGHT MODE23

SURROUND MODE24

OTHER FUNCTION.....27

 ATTENUATION TO ANALOG INPUT SIGNAL27

 LISTENING THROUGH HEADPHONES27

 VIDEO ON/OFF27

 DISPLAY MODE27

 SELECTING ANALOG AUDIO INPUT OR DIGITAL AUDIO INPUT27

 RECORDING AN ANALOG SOURCE28

 HT-EQ28

 7.1 CH INPUT.....28

 7.1 CH INPUT LEVEL.....29

BASIC OPERATION (TUNER).....30

 LISTENING TO THE TUNER.....30

 PRESET MEMORY30

SURROUND SPEAKER B SYSTEM.....32

 MULTI ROOM PLAYBACK USING THE S(SURROUND)

 SPEAKER B TERMINALS32

TROUBLESHOOTING33

TECHNICAL SPECIFICATIONS.....34

DIMENSIONS34

FOREWORD

This section must be read before any connection is made to the mains supply.

EQUIPMENT MAINS WORKING SETTING

Your Marantz product has been prepared to comply with the household power and safety requirements that exist in your area.
SR3001 can be powered by 120V AC only.

COPYRIGHT

Recording and playback of any material may require consent. For further information refer to the following:

- Copyright Act 1956
- Dramatic and Musical Performers Act 1958
- Performers Protection Acts 1963 and 1972
- any subsequent statutory enactments and orders

INTRODUCTION

Thank you for purchasing the Marantz SR3001 Surround receiver.

This remarkable component has been engineered to provide you with many years of home theater enjoyment. Please take a few minutes to read this manual thoroughly before you connect and operate the SR3001.

As there are a number of connection and configuration options, you are encouraged to discuss your own particular home theater setup with your Marantz A/V specialist dealer.

PRECAUTIONS

CAUTIONS ON INSTALLATION

For heat dispersal, leave at least 8 inch (0.2 m) of space between the top, back and sides of this unit and the wall or other components.

- Do not obstruct the ventilation holes.

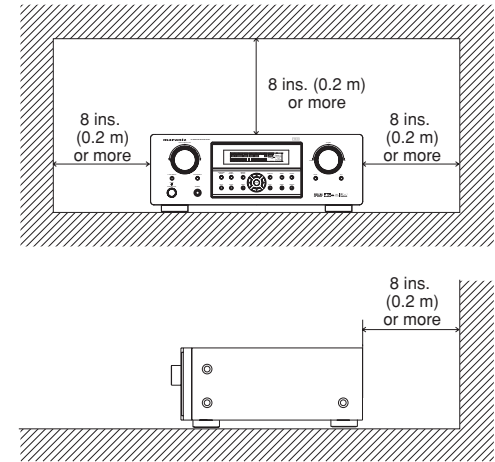

DESCRIPTION

DIGITAL
dts
SURROUND

DTS was introduced in 1994 to provide 5.1 channels of discrete digital audio into home theater systems.

DTS brings you premium quality discrete multichannel digital sound to both movies and music.

DTS is a multichannel sound system designed to create full range digital sound reproduction.

The no compromise DTS digital process sets the standard of quality for cinema sound by delivering an exact copy of the studio master recordings to neighborhood and home theaters.

Now, every moviegoer can hear the sound exactly as the moviemaker intended.

DTS can be enjoyed in the home for either movies or music on of DVD's, LD's, and CD's.

"DTS" and "DTS Digital Surround" are registered trademarks of Digital Theater Systems, Inc.

dts NEO:6

The advantages of discrete multichannel systems over matrix are well known.

But even in homes equipped for discrete multichannel, there remains a need for high-quality matrix decoding. This is because of the large library of matrix surround motion pictures available on disc and on VHS tape; and analog television broadcasts.

The typical matrix decoder of today derives a center channel and a mono surround channel from two-channel matrix stereo material. It is better than a simple matrix in that it includes steering logic to improve separation, but because of its mono, band-limited surround it can be disappointing to users accustomed to discrete multichannel.

Neo:6 offers several important improvements as follow,

- Neo:6 provides up to six full-band channels of matrix decoding from stereo matrix material. Users with 6.1 and 5.1 systems will derive six and five separate channels, respectively, corresponding to the standard home-theater speaker layouts.
- Neo:6 technology allows various sound elements within a channel or channels to be steered separately, and in a way which follows naturally from the original presentation.
- Neo:6 offers a music mode to expand stereo nonmatrix recordings into the five- or six-channel layout, in a way which does not diminish the subtlety and integrity of the original stereo recording.

EXTENDED
dts ES
SURROUND

DTS-ES Extended Surround is a new multichannel digital signal format developed by Digital Theater Systems Inc. While offering high compatibility with the conventional DTS Digital Surround format, DTS-ES Extended Surround greatly improves the 360-degree surround impression and space expression thanks to further expanded surround signals. This format has been used professionally in movie theaters since 1999.

In addition to the 5.1 surround channels (FL, FR, C, SL, SR and LFE), DTS-ES Extended Surround also offers the SB (Surround Back) channel for surround playback with a total of 6.1 channels. DTS-ES Extended Surround includes two signal formats with different surround signal recording methods, as DTS-ES Discrete 6.1 and DTS-ES Matrix 6.1.

"DTS", "DTS-ES" and "Neo:6" are trademarks of Digital Theater Systems, Inc.

dts 96/24

The stereo CD is a 16-bit medium with sampling at 44.1 kHz. Professional audio has been 20- or 24-bit for some time, and there is increasing interest in higher sampling rates both for recording and for delivery into the home. Greater bit depths provide extended dynamic range. Higher sampling rates allow wider frequency response and the use of anti-alias and reconstruction filters with more favorable aural characteristics.

DTS 96/24 allows for 5.1 channel sound tracks to be encoded at a rate of 96kHz/24bits on DVD-Video titles.

When DVD-video appeared, it became possible to deliver 24-bit, 96 kHz audio into the home, but only in two channels, and with serious limitations on picture. This capability has had little use.

DVD-audio allows 96/24 in six channels, but a new player is needed, and only analog outputs are provided, necessitating the use of the D/A converters and analog electronics provided in the player.

DTS 96/24 offers the following:

1. Sound quality transparent to the original 96/24 master.
2. Full backward compatibility with all existing decoders. (Existing decoders will output a 48 kHz signal)

3. No new player required: DTS 96/24 can be carried on DVD-video, or in the video zone of DVD-audio, accessible to all DVD players.

4. 96/24 5.1-channel sound with full-quality full-motion video, for music programs and motion picture soundtracks on DVD-video.

"DTS" and "DTS 96/24" are trademarks of Digital Theater Systems, Inc.

DD DOLBY
DIGITAL • EX
PRO LOGIC IIx

Dolby Digital identifies the use of Dolby Digital audio coding for such consumer formats as DVD and DTV. As with film sound, Dolby Digital can provide up to five full-range channels for left, center, and right screen channels, independent left and right surround channels, and a sixth (".1") channel for low-frequency effects.

Dolby Surround Pro Logic II is an improved matrix decoding technology that provides better spatiality and directionality on Dolby Surround program material; provides a convincing three-dimensional soundfield on conventional stereo music recordings; and is ideally suited to bring the surround experience to automotive sound. While conventional surround programming is fully compatible with Dolby Surround Pro Logic II decoders, soundtracks will be able to be encoded specifically to take full advantage of Pro Logic II playback, including separate left and right surround channels. (Such material is also compatible with conventional Pro Logic decoders.)

Dolby Digital EX creates six full-bandwidth output channels from 5.1-channel sources. This is done using a matrix decoder that derives three surround channels from the two in the original recording. For best results, Dolby Digital EX should be used with movies soundtracks recorded with Dolby Digital Surround EX.

About Dolby Pro Logic IIx

Dolby Pro Logic IIx technology delivers a natural and immersing 7.1-channel listening experience to the home theater environment. A product of Dolby's expertise in surround sound and matrix decoding technologies, Dolby Pro Logic IIx is a complete surround sound solution that maximizes the entertainment experience from stereo as well as 5.1-channel encoded sources.

Dolby Pro Logic IIx is fully compatible with Dolby Surround Pro Logic technology and can optimally decode the thousands of commercially available Dolby Surround encoded video cassettes and television programs with enhanced depth and spatiality. It can also process any high-quality stereo or Advanced Resolution 5.1-channel music content into a seamless 6.1- or 7.1-channel listening experience.

Manufactured under license from Dolby Laboratories. "Dolby", "Pro Logic", and the double-D symbol are trademarks of Dolby Laboratories.

SRS (C) (C)
Circle Surround II

Circle Surround II (CS-II) is a powerful and versatile multichannel technology. CS-II is designed to enable up to 6.1 multichannel surround sound playback from mono, stereo, CS encoded sources and other matrix encoded sources. In all cases the decoder extends it into 6 channels of surround audio and a LFE/subwoofer signal. The CS-II decoder creates a listening environment that places the listener "inside" music performances and dramatically improves both hi-fi audio conventional surround-encoded video material. CS-II provides composite stereo rear channels to greatly improve separation and image positioning – adding a heightened sense of realism to both audio and A/V productions.

CS-II is packed with other useful feature like dialog clarity (SRS Dialog) for movies and cinema-like bass enrichment (TruBass). CS-II can enable the dialog to become clearer and more discernable in movies and it enables the bass frequencies contained in the original programming to more closely achieve low frequencies – overcoming the low frequency limitations of the speakers by full octave.

Circle Surround II, Dialog Clarity, TruBass, SRS and (C) (C)® symbol are trademarks of SRS Labs, Inc. Circle Surround II, Dialog Clarity and TruBass technology are incorporated under license from SRS Labs, Inc.



HDCD® (High Definition Compatible Digital®) is a patented process for delivering on Compact Disc the full richness and details of the original microphone feed.

HDCD encoded CDs sound better because they are encoded with 20-bits of real musical information as compared to 16-bits for all other CDs.

HDCD overcomes the limitation of the 16-bit CD format by using a sophisticated system to encode the additional four bits onto the CD while remaining completely compatible with the CD format.

When listening to HDCD recordings, you hear more dynamic range, a focused 3-D sound stage, and extremely natural vocal and musical timbre. With HDCD, you get the body, depth and emotion of the original performance not a flat, digital imitation.

HDCD system manufactured under license from Microsoft. This product is covered by one or more of the following: In the United States 5,479,168 5,638,074 5,640,161 5,808,574 5,838,274 5,854,600 5,864,311 5,872,531 and in Australia 669,114 with other patents pending.

FEATURES

The SR3001 incorporates the latest generation of digital surround sound decoding technology such as Dolby Digital EX, Dolby Digital, DTS ES (Discrete 6.1 and Matrix 6.1), DTS Neo:6 (Cinema, Music), Dolby Pro-Logic IIx (Movie, Music and Game), Circle Surround II (Cinema and Music).

In addition, Marantz has focused on the future. By utilizing pre-out jack, 7.1 direct inputs the SR3001 is tomorrow's technology, today!

The SR3001 features a fully discrete 7 channel amplifier section capable of delivering 60 watts of high-current amplification, for continuously clean and stable power into each of the seven channels. It employs a massive EI power transformer in combination with oversized filter capacitors. This design configuration is capable of a clear and powerful reproduction of the most demanding action movie soundtracks and full range (multichannel) music discs. Through its ability to generate very high output voltages, the SR3001 can easily drive the most demanding speakers with optimum results.

The SR3001 incorporates the most advanced Digital Signal Processing circuitry, along with a Crystal® 192 kHz/24 bit D/A converter in each of the 7 channels. Independent power supply circuits are incorporated for the FL display, audio and video sections for maximum separation, clarity and dynamic range. Together with hand-selected customized components, all elements work in harmony to recreate the emotion, exactly as the artist had intended.

The SR3001 is designed and engineered with extensive feedback from dealers and consumers. It features a heavy duty speaker binding posts and an extensive array of both analog and digital inputs / outputs. With 3 assignable digital inputs, 2 component inputs and SACD Multi Channel (7.1 channel) direct inputs is taken to a stunning new level.

An easy-to-use universal remote control allows full access to all of the operating functions and can be used for system operation as well.

This unit has Simple Setup function for easy setup. You can setup all speaker settings by just selecting your room size and the number of your speakers with Simple Setup function. You can also setup customized settings just like conventional AV amplifiers.

The TruSurround Headphone technology provides a surround sound listening experience over headphones.

When listening to multichannel content such as DVD movies over headphones, the listening experience is fundamentally different than listening to speakers. Since the headphone speaker drivers are covering the pinna of the ear, the listening experience differs greatly from traditional speaker playback. TruSurround utilizes patented headphone perspective curves to solve this problem and provides a non-fatiguing, immersive, home theater listening experience. TruSurround Headphone also delivers exceptional 3D audio from mono and stereo material.

- Dolby Digital EX, Dolby Digital , DTS ES (Discrete 6.1, Matrix 6.1, Neo: 6)
- Dolby Pro Logic IIx (Movie, Music, Game)
- Circle Surround II (Movie, Music, Mono)
- HDCD decoding
- 7 × 60 Watts (8 Ohm), Discrete Amplifiers
- Massive Energy Power Supply, Huge EI Transformer, Large ELCO's.
- 192 kHz/24 bit Crystal® DAC for all 7 Channels
- 32 bit Digital Surround Processing Chipsets
- Video Off Mode
- Large Heavy Duty Speaker Terminals for all Channels
- Auto Input Signal Detection
- Improved Station Name Input Method, 50 Presets
- Auto Adjust Function for Speaker Distance Settings (Delay Time)
- Universal remote control
- Simple Setup Function

ACCESSORIES

Remote Controller RC5500SR

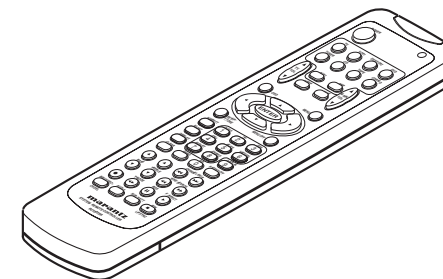

AAA-size batteries × 2

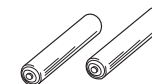

AM Loop Antenna

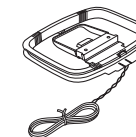

FM Antenna

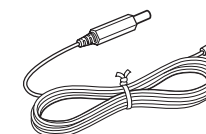

User Guide

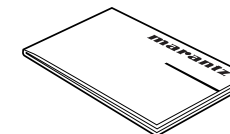

FRONT PANEL

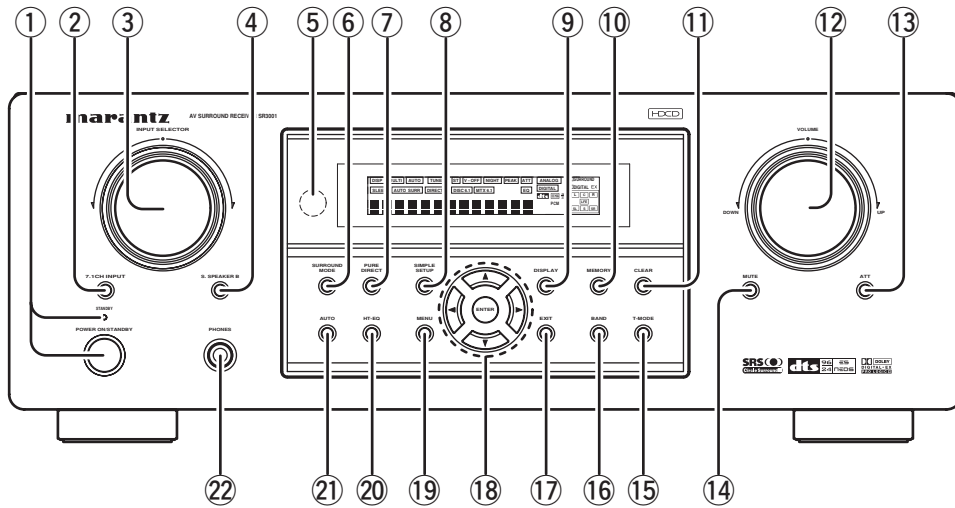

① POWER switch and STANDBY indicator

When this switch is pressed once, the unit turns ON and the display illuminates. When pressed again, the unit turns OFF and the STANDBY indicator will be illuminated.

② 7.1CH INPUT button

Press this button to select the output of an external multichannel player.

③ INPUT SELECTOR knob (AUDIO/VIDEO)

This knob is used to select the input sources. The video function selector, such as TV, DVD, VCR1 and DSS, selects video and audio simultaneously. Audio function sources such as CD, TAPE, CDR/MD, and TUNER may be selected in conjunction with a Video source.

This feature (Sound Injection) combines a sound from one source with a picture from another. Choose the video source first, and then choose a different audio source to activate this function.

④ S.(Surround) SPEAKER B button

Press this button to activate the Surround Speaker B system. "SPKR B" indicator will be illuminated in the display. (See page 33)

⑤ INFRARED receiving sensor window

This window receives infrared signals for the remote control.

⑥ SURROUND MODE button

You can select the surround mode by pressing this button.

⑦ PURE DIRECT button

When this button is pressed, the tone control circuitry is bypassed as well as Bass Management. DIRECT indicator will be illuminated in the display.

Notes:

- The surround mode is automatically switched to AUTO when the pure direct function is turned on.
- Additionally, Speaker Configurations are fixed automatically as follows.
Front SPKR = Large, Center SPKR = Large, Surround SPKR = Large, Sub woofer = On
- This function is unavailable when the surround speaker B system is activated. While this function is activated, this function will be canceled if the S. SPEAKER B button is pressed.

⑧ SIMPLE SETUP button

Press this button to enter the simple setup mode. You can setup the speaker conditions (speaker sizes, number of speakers, speaker delay times) quickly by pressing the cursor buttons.

⑨ DISPLAY button

When this button is pressed, the FL display mode is changed as Surround Mode → Auto-display Off → Display Off → Input Function and the display off indicator(DISP) lights up in condition of DISPLAY OFF.

⑩ MEMORY button

Press this button to enter the tuner preset memory numbers or station names. (See page 30)

⑪ CLEAR button

Press this button to cancel the station-memory setting mode or preset scan tuning. (See page 31)

⑫ VOLUME control knob

Adjusts the overall sound level. Turning the control clockwise increases the sound level.

⑬ ATT (Attenuate) button

If the selected analog audio input signal is greater than the capable level of internal processing, the PEAK indicator will illuminate. If this happens, you should press the ATT button. "ATT" is displayed when this function is activated.

The signal-input level is reduced by about half. Attenuation will not work with the output signal of "REC OUT" (TAPE, CD-R/MD, VCR1 and VCR2 output). This function is memorized for each input function.

⑭ MUTE button

Press this button to mute the output to the speakers. Press it again to return to the previous volume level.

⑮ T-MODE button

Press this button to select the auto stereo mode or mono mode when the FM band is selected. The "AUTO" indicator lights in the auto stereo mode. (See page 30)

⑯ BAND button

Press this button to switch between FM and AM in the TUNER mode.

⑰ EXIT button

This button is used to exit from the SETUP MAIN MENU.

⑱ Cursor (Left, Right, Up, Down) / ENTER button

Use these buttons when operating the SETUP MAIN MENU and TUNER function.

⑲ MENU button

This button is used to enter the SETUP MAIN MANU.

⑳ HT-EQ button

Used to turn on or off HT(Home Theater)-EQ mode. This mode compensates for the audio portion of a movie sounding "bright". When this button is pressed, "EQ" indicator lights up.

㉑ AUTO (Auto surround) button

Press this button to select the AUTO mode from the surround modes. When this mode is selected, the receiver determines the surround mode corresponding to a digital input signal automatically.

22 HEADPHONE jack for stereo headphones

This jack may be used to listen to the SR3001's output through a pair of headphones. Be certain that the headphones have a standard 1 / 4" stereo phono plug. Note that the main room speakers will automatically be turned off when the headphone jack is in use.

Notes:

- When using headphones, the surround mode will change to STEREO and TruSurround (TS) headphones by SURROUND MODE button.
- The surround mode returns to the previous setting as soon as the headphone plug is removed from the jack.

FL DISPLAY

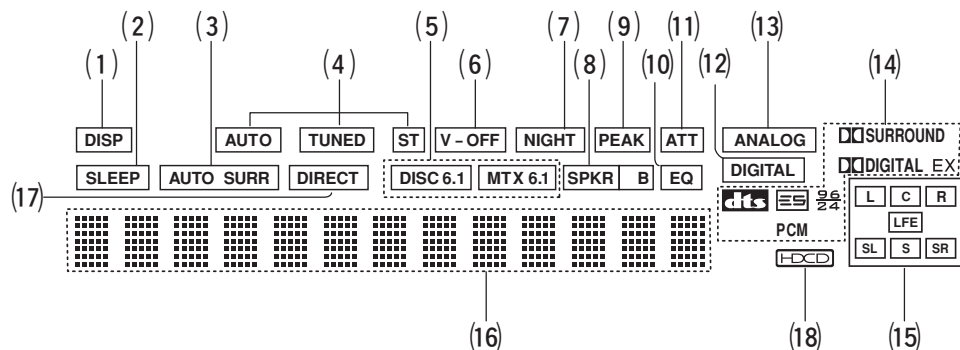

(1) DISP (Display Off) indicator

This indicator is illuminated when the SR3001 is in the display off condition.

(2) SLEEP timer indicator

This indicator is illuminated when the sleep timer function is active.

(3) AUTO SURR (Auto Surround mode) indicator

This indicator is illuminated to show that the AUTO SURROUND mode is in use.

(4) TUNER's indicators

AUTO : This indicator illuminates when the tuner's Auto mode is in use.

TUNED : This indicator illuminates when a station is being received with sufficient signal strength to provide acceptable listening quality.

ST(Stereo) : This indicator illuminates when an FM station is being tuned into stereo condition.

(5) DTS-ES mode indicators (DISC6.1, MTX6.1)

These indicators will illuminate to show the DTS-ES decoding mode (Discrete 6.1 or Matrix 6.1).

(6) V (video)-OFF mode indicator

This indicator is illuminated when the Video-OFF function is active.

(7) NIGHT mode indicator

This indicator is illuminated when the SR3001 is in the Night mode, which reduces the dynamic range of digital program material at low volume levels.

(8) SPKR (Speaker) B indicator

This indicator is illuminated when the S(Surround) speaker B system is active.

(9) PEAK indicator

This indicator is a monitor for an analog audio input signal. If the selected analog audio input signal is greater than the capable level of internal processing, this will illuminate. If this happens, you should press the **ATT** button on the front panel or the remote.

(10) EQ mode indicator

This indicator is illuminated when the HT-EQ function is active.

(11) ATT (Attenuation) indicator

This indicator is illuminated when the attenuation function is active.

(12) DIGITAL Input Indicator

This indicator lights when a digital input has been selected.

(13) ANALOG input indicator

This indicator is illuminated when an analog input source has been selected.

(14) SIGNAL FORMAT indicators

DIGITAL, EX, SURROUND, dts, ES, 96/24, PCM

When the selected input is a digital source, some of these indicators will be illuminated to display the specific type of signal in use.

(15) ENCODED CHANNEL STATUS indicators

These indicators display the channels that are encoded with a digital

input signal. If the selected digital input signal is Dolby Digital 5.1ch or DTS 5.1ch, "L", "C", "R", "SL", "SR" and "LFE" will be illuminated. If the digital input signal is 2 channel PCM-audio, "L" and "R" will be displayed.

If Dolby Digital 5.1ch signal with Surround EX flag or DTS-ES signal comes in, "L", "C", "R", "SL", "S", "SR" and "LFE" will be illuminated.

(16) Main Information Display

This display shows messages relating to the status, input source, surround mode, tuner, volume level or other aspects of unit's operation.

(17) DIRECT (Pure direct) indicator

This indicator is illuminated when the SR3001 is in the PURE DIRECT mode.

(18) HDCD indicator

When HDCD signal is decoded from digital input, this indicator will light up.

REAR PANEL

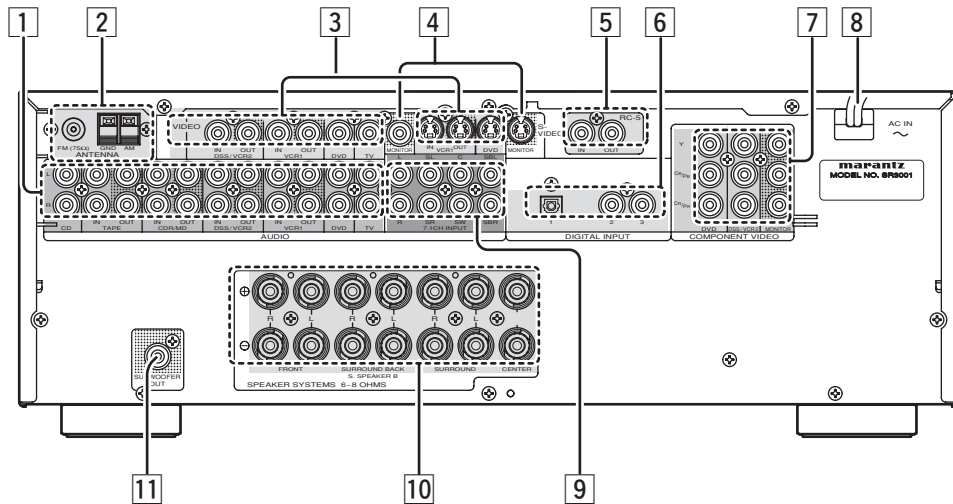

1 AUDIO IN/OUT (CD, TAPE, CD-R/MD, TV, DVD, VCR1, DSS/VCR2)

These are the analog audio inputs and outputs. There are 7 audio inputs (4 of which are linked to video inputs) and 4 audio outputs (2 of which are linked to video outputs). The audio jacks are nominally labeled for cassette tape decks, compact disc players, DVD players and etc.... The audio inputs and outputs require RCA-type connectors.

2 FM antenna terminal (75 ohms)

Connect an external FM antenna with a coaxial cable, or a cable network FM source.

AM antenna and ground terminals

Connect the supplied AM loop antenna. Use the terminals marked "AM" and "GND". The supplied AM loop antenna will provide good AM reception in most areas. Position the loop antenna until you hear the best reception.

3 VIDEO IN/OUT (TV, DVD, VCR1, DSS/VCR2)

These are the video inputs and outputs. There are 4 video inputs and 2 video outputs and each one includes both composite video and S-video configurations. Connect VCRs, DVD players, and other video components to the video inputs. The 2 video output channels can be used to be connected to video tape recorders for making recordings.

4 MONITOR OUT

This is a monitor output and each one includes both composite video and S-video configurations.

5 REMOTE CONT. IN/OUT terminals

Connect to a Marantz component equipped with remote control (RC-5) terminals.

6 DIGITAL INPUT (Dig.1 - 3) (coaxial, optical)

There are 2 digital inputs with coaxial jacks, 1 with optical jack. The inputs accept digital audio signals from a compact disc, LD, DVD, or other digital source component.

7 COMPONENT VIDEO INPUT/OUTPUT

If your DVD player or other device has component video connectors, be sure to connect them to these component video connectors on the SR3001. The SR3001 has two component video input connectors to obtain the color information (Y, C_B, C_R) directly from the recorded DVD signal or other video component and one component video output connector to output it directly into the matrix decoder of the display device. By sending the pure DVD component video signal directly, the DVD signal forgoes the extra processing that normally would degrade the image. The result is vastly increased image quality, with incredibly life like colors and crisp detail.

8 AC Power Cord

Connect to an AC power outlet. SR3001 has to be powered by 120V AC only.

9 7.1 CHANNEL INPUT

By connecting a DVD Audio player, SACD multichannel player, or other components that has a multichannel port, you can playback the audio with 5.1 channel or 7.1 channel outputs.

10 Speaker outputs terminals

Seven terminals are provided for the front left, front right, front center, surround left, surround right, surround back left and surround back right speakers.

Note:

You can use surround back speaker terminals as S(Surround) SPEAKER B terminals, when you use no surround back speaker.

11 Subwoofer Output

Connect this jack to the line level input of a powered subwoofer. If an external subwoofer amplifier is used, connect this jack to the subwoofer amplifier input. If you are using two subwoofers, either powered or with a 2 channel subwoofer amplifier, connect a "Y" connector to the subwoofer output jack and run one cable from it to each subwoofer amplifier.

REMOTE CONTROL OPERATION

FUNCTION AND OPERATION

The provided remote control unit is a universal remote controller. The **POWER** button, numeric buttons and control buttons are used in common across different input source components.

The input source controlled with the remote control unit changes when one of the input selector buttons is pressed.

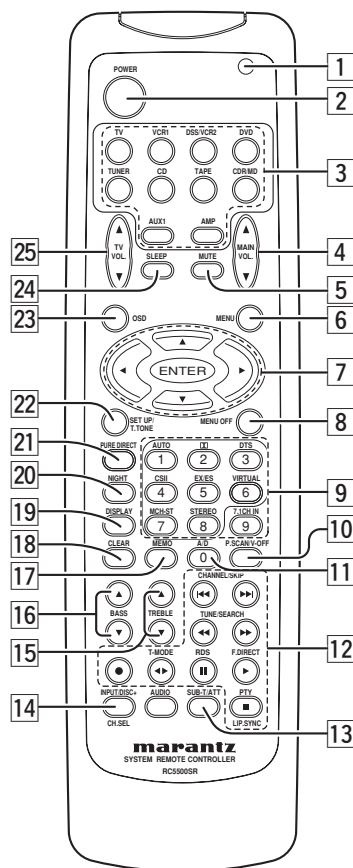

1 Transmitting indicator

Lights up during a button is pressed and an infra-red signal is sending.

2 (Main) POWER buttons

(when AMP mode is selected)

Press to switch the power of the SR3001 ON or OFF after pressing the **AMP** button.

3 Input selector buttons/ FUNCTION SELECTOR buttons (AUDIO/VIDEO INPUT)

These buttons are used to select a Audio or Video source component. Press one of these buttons once to change the function of the remote control. Press same button within 2 seconds, the input function of the SR3001 is changed.

Audio function sources such as CD, TAPE, CDR/MD, and TUNER may be selected in conjunction with a Video source.

This feature (Sound Injection) combines a sound from one source with a picture from another. Choose the video source first, and then choose a different audio source to activate this function.

Notes:

- CDR/MD button is set CDR function at initial. To switch MD function, press and hold down CDR/MD button and press 2 button.
- To return CDR function, press and hold down CDR/MD button and press 1 button.

4 MAIN VOLUME UP (▲) /DOWN (▼) buttons

Main volume control of the SR3001. The front, surround, center and subwoofer channel volumes controlled by these buttons simultaneously.

5 MUTE button

Muting button of the SR3001. Press this button decrease the sound temporarily. Press this button again to return to the previous sound. When this button is pressed, "MUTE" indicator lights up.

6 MENU button

(when AMP mode is selected)

This button is used to enter the SETUP MAIN MENU.

7 Cursor (◀, ▶, ▲, ▼) / OK buttons

(when AMP mode is selected)

Use these button when operating the SETUP MAIN MENU.

8 MENU OFF button

(when AMP mode is selected)

This button is used to exit from the SETUP MAIN MENU.

9 Numeric buttons 1 to 9 / Surround mode buttons

Numeric buttons

These buttons are used to enter figures in the selection of a tuner preset station and station name preset or to set select a CD track number, etc. The functions of these buttons are dependent on the function button selected.

Surround mode buttons

(when AMP mode is selected)

These buttons are used to select the surround mode.

10 P.SCAN (Preset scan) / V(Video)-OFF button

(when TUNER mode is selected)

This button is used to start preset scan when SR3001 is selected TUNER mode.

(when AMP mode is selected)

This is used when switching the video signals from the various monitor outputs to Video-Off mode.

11 0 / A/D button

0 button

This button is used to enter the number "0"

A/D button *(when AMP mode is selected)*

This is used to switch between the analog and digital inputs.

12 CONTROL buttons

These buttons are used when operating the CD player, TAPE deck, etc.

The function of these buttons are dependent on the function button selected.

For the controllable functions of each input function, please refer to controllable function table on the page 10.

13 SUB-T (Title) / ATT (attenuator) button

When the input signal is too high and the voice distorts even while adjusting the SR3001 VOLUME control, turn on this function. "ATT" is illuminated when this function is activated.

The input level is reduced. Attenuator is invalid for the output signal of "REC OUT".

Note:

This function is unavailable while the digital input is selected.

14 INPUT/DISC+ / CH.SEL buttons

This button is used to enter the input level setup menu.

15 TREBLE UP (▲) /DOWN (▼) buttons

These buttons are used to adjust the tone control of high frequency sound for left and right speaker.

16 BASS UP (▲) /DOWN (▼) buttons

These buttons are used to adjust the tone control of low frequency sound for left, right and subwoofer speaker.

17 MEMO button

Memory enable button for various preset functions.

18 CLEAR button

This button is used to cancel for certain memory or programming operations.

19 DISPLAY button

Selects the display mode for the front display of the SR3001.

20 NIGHT button

Pressing this button prevents the Dolby Digital signal from playback at a loud voice. This function reduces the voice by 1/3 to 1/4 at maximum. Thus, it eliminates the occurrence of an abruptly loud voice at night. However, the function is valid only in the case when the Dolby Digital signal is entered into OPTICAL or COAXIAL and data to compress the voice exists in the signal to be played back. When this button is pressed, the "NIGHT" indicator is illuminated.

21 PURE DIRECT button

When this button is pressed, the tone control circuit is bypassed.

22 SETUP / T.TONE button

(when AMP mode is selected)
Used to enter the test tone menu.

23 OSD button

Note:

This button is unavailable for SR3001.

24 SLEEP (sleep timer) button

This button is used for setting the sleep timer. It can be operated the same way as the button on the unit.

25 TV VOLUME UP (▲) /DOWN (▼) buttons

These buttons increase or decrease TV's volume.

PROGRAMMING THE REMOTE CONTROLLER

The remote controller RC5500SR must be programmed to use the codes for your appliances of different brands. This is done by keying in a 4-digit code or by scanning the codes until the correct one is found. We recommend to using the 4-digit code. This mode is faster and more reliable. The code scanning method should be used only if you cannot find the code for one of your appliances. The codes are listed at the end of this book.

Important:

- Use the remote control buttons for programming, not the buttons of the receiver or other appliances.
- Some codes may not match your equipment. In this case, your equipment cannot be controlled with this remote controller.

PROGRAMMING WITH THE 4-DIGIT CODE

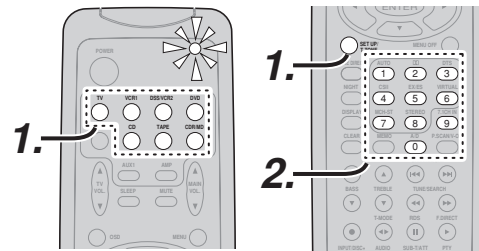

1. Press and hold down the **Function Selector** button for the appliance which should be controlled and press **SETUP** button until the indicator blinks twice.
2. Press the 4-digit code for appliance (code table at the end of this book)
3. When the procedure is successful, the indicator will blink twice.

Note:

If the indicator did not blink twice, then repeat steps 1 through 2 and try entering the same code again.

SCANNING THE CODE TABLE

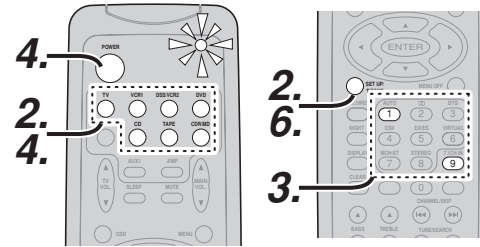

1. Switch on the appliance which should be controlled.
2. Press and hold down the **Function Selector** button for appliance which should be controlled and press **SETUP** button until the indicator blinks twice.
3. Press the code **9 - 9 - 1**.
The indicator will blink twice.
4. Aim the remote control at the appliance and slowly alternate between pressing **POWER** button and the **Function Selector** button for the appliance.
5. Stop when the appliance turns off.
6. Press **SETUP** button once to lock in the code.

CHECKING THE CODE

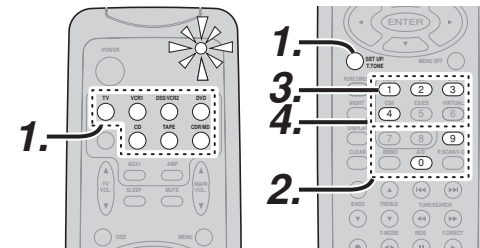

1. Press and hold down the **Function Selector** button for appliance which should be controlled and press **SETUP** button until the indicator blinks twice.
2. Press the code **9 - 9 - 0**.
The indicator will blink twice.
3. To view the code for first digit, press **1** once.
Wait 3 seconds, count the indicator blinks (e.g. 3 blinks = 3) and write down the number.

Note:

If a code digit is "0", the indicator will not blink.

4. Repeat step 3 three more times for remaining digits. Use **2** for the second digit, **3** for the third digit, and **4** for the fourth digit.

RESETTING THE ALL CODE

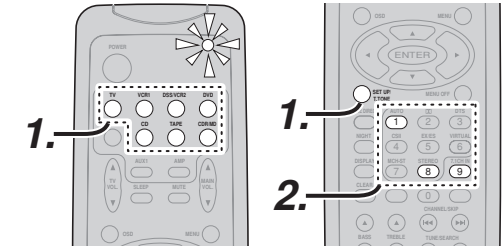

1. Press and hold down the any **Function Selector** button and press **SETUP** button until the indicator blinking twice.
2. Press the code **9 - 8 - 1**.
The indicator will blink twice.
Then, RC5500SR will return to the factory preset code.

Note:

After this procedure, the selected function button is set initial code and other function buttons are set initial code too.

Once you have found and the codes for your various appliances, you may want to write them down here.

- TV _____
- VCR _____
- DSS _____
- DVD _____
- CD _____
- TAPE _____
- CDR _____
- MD _____

OPERATION OF REMOTE CONTROL UNIT

REMOTE CONTROL

The distance between the transmitter of the remote control and the IR SENSOR of the SR3001 should be less than 5 meters. If the remote control is pointed in a direction other than the IR SENSOR or if there is an obstacle between them, use of the remote control may not be possible.

Remote-controllable range

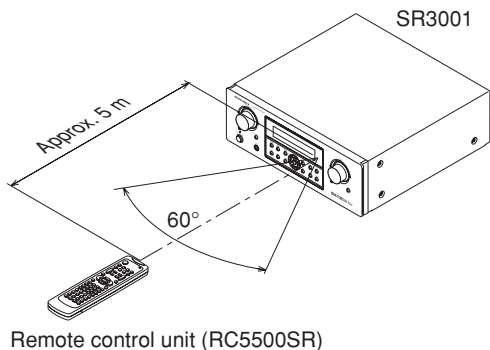

LOADING BATTERIES

The life of the batteries used with the remote control is about 4 months with normal use. Also be sure to replace batteries earlier when you notice that they are getting weak.

1. Remove the back cover.

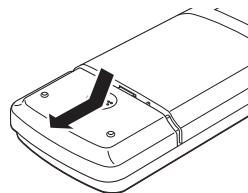

2. Insert the new batteries (AAA type) with correct + and - polarity.

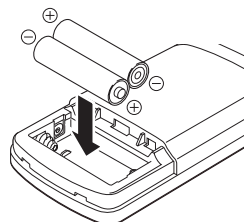

3. Close the cover until it clicks.

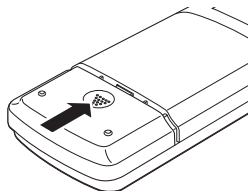

GENERAL INFORMATION OF RC5500SR TO SR3001

To control the SR3001 by your RC5500SR, you have to select the device AMP or TUNER by pressing the function selector button. Please refer below for the details in AMP and TUNER mode.

AMP MODE

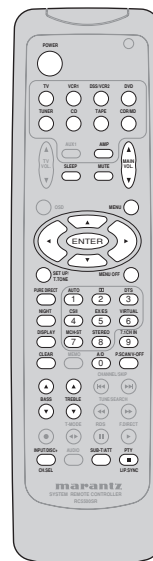

POWER	Turns the SR3001 on and off
Function selector *	Selects a particular source component
SLEEP *	Sets the sleep timer function
MUTE *	Decreases the sound temporarily
VOL ▲▼ *	Adjusts the over all sound level
MENU	Enters the SETUP MENU
Cursor	Moves the cursor for settings in the SETUP MENU
ENTER	• Enters the SETUP MENU • Confirms the settings in SETUP MENU
SETUP/T.TONE	Enters the test tone mode for setting the Speaker Level Setup
MENU OFF	Exits from the SETUP MENU
PURE DIRECT *	Selects the Pure Direct mode
NIGHT *	Turns on or off the NIGHT mode
DISPLAY *	Change the front display mode
Surround mode (1-8)	Selects the surround mode
7.1CH-IN (9)	Selects the 7.1CH IN
A/D (0)	Switches between the analog and digital inputs
BASS ▲▼ *	Adjusts the tone control of low frequency sound
TREBLE ▲▼ *	Adjusts the tone control of high frequency sound
SUB-T/ATT	Reduces the input level
P.SCAN/V-OFF	Turns on or off the Video output
CH. SEL	Adjusts the input level
LIP.SYNC	Selects the LIP. SYNC mode

* These buttons are used to control SR3001 in any function mode.

TUNER MODE



TUNER	Selects a frequency band
0-9	Inputs the numeric #s
CLEAR	Clears the inputting
MEMO	Enters the tuner preset memory numbers
P.SCAN/V-OFF	Starts preset scan
CHANNEL/SKIP	• Selects a preset station • Changes a PTY type *
TUNE/SEARCH	Tunes a station
◀▶	Selects the auto stereo mode or mono mode
RDS ■	Selects the display mode in RDS *
F.DIRECT ▶	Selects the "Frequency direct input"
PTY ■	Displays the programmed information of the current station *

* : European model only

THE CONTRABLE FUNCTION TABLE

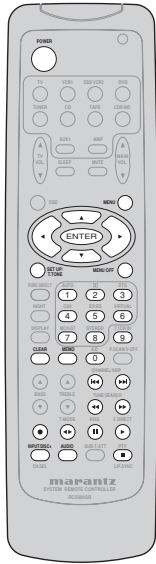

	TV	VCR	DVD	DSS	CD	TAPE	CDR	MD
POWER	POWER	POWER	POWER	POWER	POWER	POWER	POWER	POWER
MENU	CALL UP MENU	CALL UP MENU	CALL UP MENU	CALL UP MENU	SWITCH DISPLAY	SWITCH DISPLAY	SWITCH DISPLAY	SWITCH DISPLAY
Cursor	Cursor	Cursor	Cursor	Cursor	-	-	-	-
ENTER	OK	OK	OK	OK	-	-	-	-
SETUP/T.TONE	-	-	SETUP MENU	-	-	-	-	-
MENU OFF	-	CANCEL MENU	-	CANCEL MENU	-	-	-	-
0 - 9	INPUT NUMERIC	INPUT NUMERIC	INPUT NUMERIC	INPUT NUMERIC	INPUT NUMERIC	INPUT NUMERIC	INPUT NUMERIC	INPUT NUMERIC
CLEAR	INPUT CLEAR	TAPE SPEED	INPUT CLEAR	INPUT CLEAR	INPUT CLEAR	INPUT CLEAR	INPUT CLEAR	INPUT CLEAR
MEMO	-	-	CALL PROGRAM	-	CALL PROGRAM	CALL PROGRAM	CALL PROGRAM	CALL PROGRAM
CHANNEL/SKIP ◀◀	CH-	PREV	PREV	CH-	PREV	PREV	PREV	PREV
CHANNEL/SKIP ▶▶	CH+	NEXT	NEXT	CH+	NEXT	NEXT	NEXT	NEXT
TUNE/SEARCH ◀◀	-	REWIND	REWIND	-	REWIND	REWIND	REWIND	REWIND
TUNE/SEARCH ▶▶	-	FF	FF	-	FF	FF	FF	FF
● (REC)	-	REC	-	-	-	REC	REC	REC
T-MODE ◀▶	-	-	-	-	-	DIRECTION	-	-
RDS	-	PAUSE	PAUSE	-	PAUSE	PAUSE	PAUSE	PAUSE
F.DIRECT ▶	-	PLAY	PLAY	-	PLAY	PLAY	PLAY	PLAY
INPUT/DISC+	INPUT SEL.	TV/VCR	DISC+	TV/DSS	DISC+	-	DISC+	-
AUDIO	-	AUDIO	AUDIO	AUDIO	-	-	-	-
PTY ■	-	STOP	STOP	-	STOP	STOP	STOP	STOP
SUB-T/ATT	-	-	SUBTITLE	-	-	-	-	-

CONNECTIONS

SPEAKER PLACEMENT

The ideal surround speaker system for this unit is 7-speaker systems, using front left and right speakers, a center speaker, surround left and right speakers, surround back left and right speakers, and a subwoofer.

For best results we recommend that all front speakers be of the same type, with identical or similar driver units. This will deliver smooth pans across the front sound stage as the action moves from side to side.

Your center channel speaker is very important as over 80 % of the dialog from a typical motion picture emanates from the center channel.

It should possess similar sonic characteristics to the main speakers. Surround channel speakers need not be identical to the front channel speakers, but they should be of high quality.

The surround center speaker is useful for playback of Dolby Digital Surround EX or DTS-ES. One of the benefits of both Dolby Digital and DTS is that surround channels are discrete full range, while they were frequency limited in earlier "Pro Logic" type systems.

Bass effects are an important part of home theater. For optimal enjoyment a subwoofer should be used as it is optimized for low frequency reproduction. If you have full range front speakers, however, they may be used in place of a subwoofer with proper setting of the switches in the menu system.

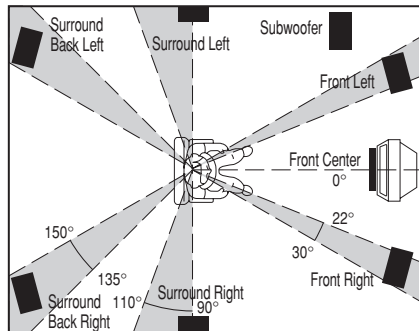

Front left and right speakers

We recommend to set the front L and R speakers with 45-60 degrees from the listening position.

Center speaker

Align the front line of the center speaker with the front L/R speakers. Or place the center speaker a little backward from the line.

Surround left and right speakers

When the SR3001 is used in surround operation, the preferred location for surround speakers is on the side walls of the room, at or slightly behind the listening position.

The center of the speaker should face into the room.

Surround back left and right speakers

Surround back speakers are required when a full 7.1-channel system is installed.

Speakers should be placed on a rear wall, behind the listening position.

The center of the speaker should face into the room.

Subwoofer

We recommend using a subwoofer to have maximum bass effect. Subwoofer bears only low frequency range so you can place it any where in the room.

HEIGHT OF THE SPEAKER UNITS

Front left and right speakers, and a center speaker

Align the tweeters and mid-range drivers on the three front speakers at the same height, as best as possible.

Surround left and right speakers, and surround back speaker

Place the surround left, right and surround back speakers higher than your ears by about 70cm – 1m. Also place the speakers at the same height, as best as possible.

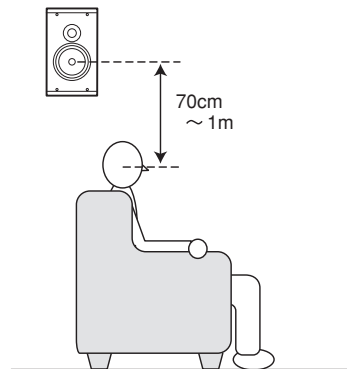

Note:

Use magnetically-shielded speakers for front left, right and the center speakers when the speakers are installed near the TV and the TV is a monitor type.

CONNECTING SPEAKERS

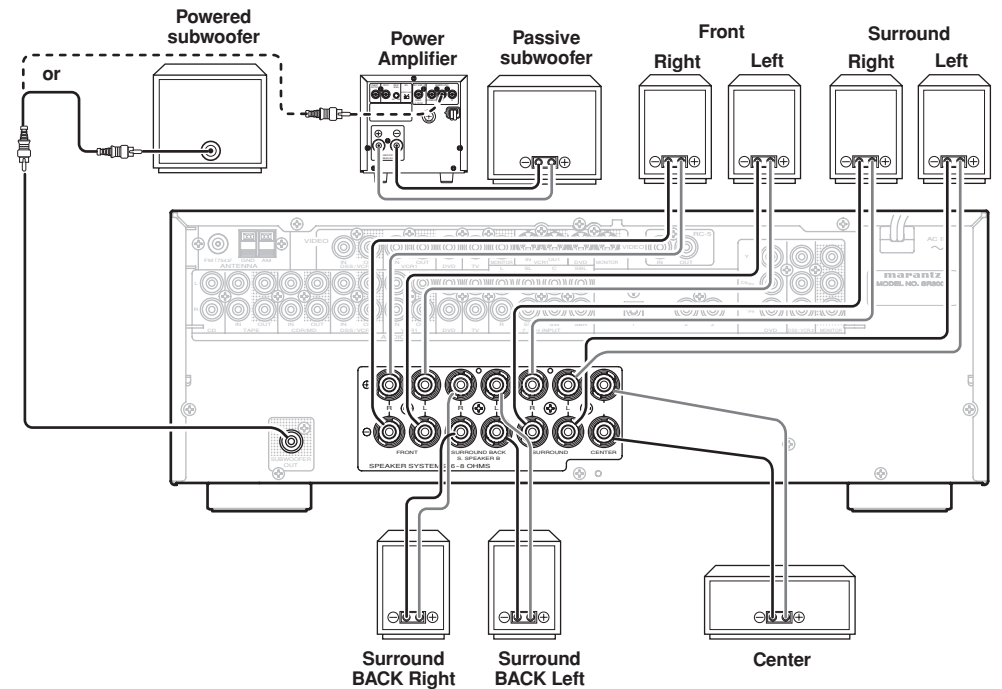

CONNECTING SPEAKER WIRE

1. Strip away approx. 3/8 inch (10 mm) of wire insulation.
2. Twist the bared wire ends tight, to prevent short circuits.
3. Loosen the knob by turning it counterclockwise.
4. Insert the bare part of the wire into the hole in side of each terminal.
5. Tighten the knob by turning it clockwise to secure the wire.

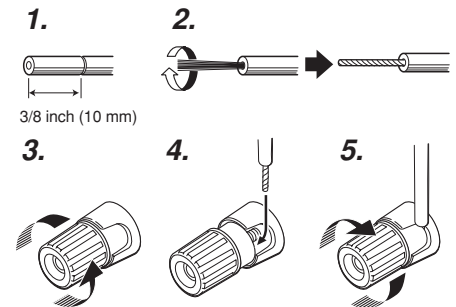

Caution:

- Be sure to use speakers with the specified impedance as shown on the rear panel of this unit.
- To prevent damage to circuitry, do not let the bare speaker wires touch each other and do not let them touch any metal part of this unit.
- Do not touch the speaker terminals when the power is on. It may cause you to receive an electric shocks.
- Do not connect more than one speaker cable to one speaker terminal. Doing so may damage this unit.

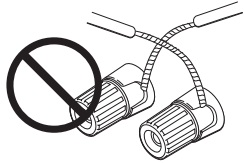

Note:

Be sure to connect the positive and negative cables for the speaker properly. If they are miss-connected, the signal phase will be reversed and the signal quality will be corrupted.

CONNECTING A SUBWOOFER

Use the PRE OUT SUBWOOFER jack to connect a powered subwoofer (power amplifier built in). If your subwoofer is a passive type (power amplifier is not built in), connect a monaural power amplifier to the PRE OUT SUBWOOFER jack and connect the subwoofer to the amplifier.

CONNECTING AUDIO COMPONENTS

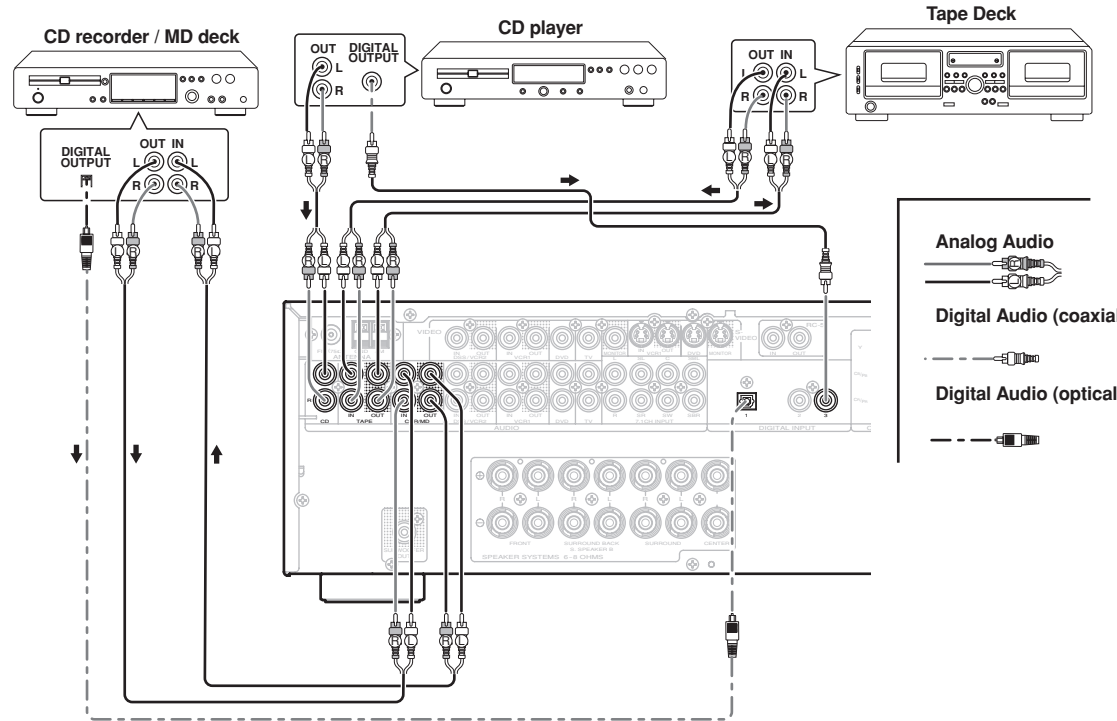

The output audio signal from the TAPE OUT jack and the CD-R/MD OUT jack is the same signal which is currently selected.

Caution:

Do not connect this unit and other components to mains power until all connections between components have been completed.

Notes:

- Insert all plugs and connectors securely. Incomplete connections may make noise.
- Be sure to connect the left and right channels properly. Red connectors are for the R (right) channel, and white connectors are for the L (left) channel.
- Be sure to connect input and output properly.
- Refer to the instructions for each component that is connected to this unit.
- Do not bind audio/video connection cables with power cords and speaker cables this will result in generating a hum or other noise.

CONNECTING DIGITAL AUDIO COMPONENTS

- There are 3 digital inputs, 2 coaxial jacks and 1 optical jack, on the rear panel. You can use these jacks to input PCM, Dolby Digital and DTS bitstream signals from a CD, DVD, or other digital source components.
- Refer to the instructions for each component. To setup the digital audio format of DVD player, or other digital source's connected to digital input jacks.
- Use fiber optical cables (optical) for DIG-1 input jacks. Use 75 ohms coaxial cables (for digital audio or video) for DIG-2, 3 input jacks.
- You can designate the input for each digital input jacks according to your component. See page 17.

Notes:

- There is no Dolby Digital RF input jack. Please use an external RF demodulator Dolby Digital decoder when connecting the Dolby Digital RF output jack of the video disc player to the digital input jack.
- The digital signal jacks on this unit conform to the EIA standard. If you use a cable that does not conform to this standard, this unit may not function properly.
- Each type of audio jack works independently. Signals input through the digital and analog jacks are output through the corresponding digital and analog jacks, respectively.

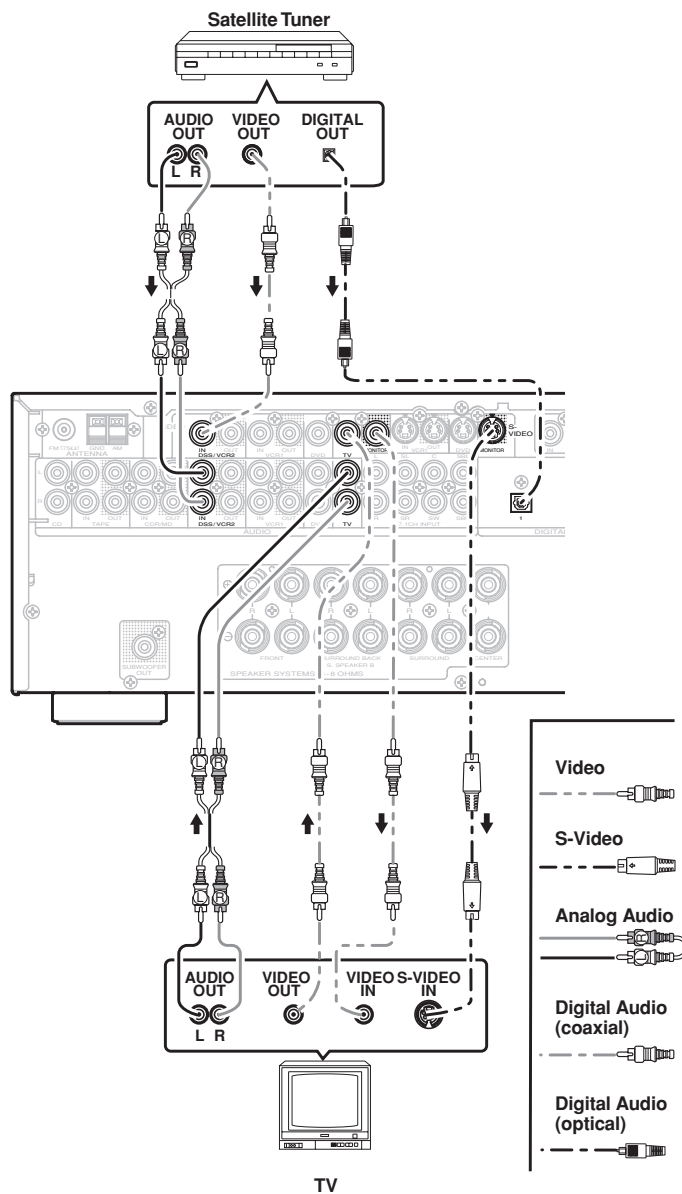
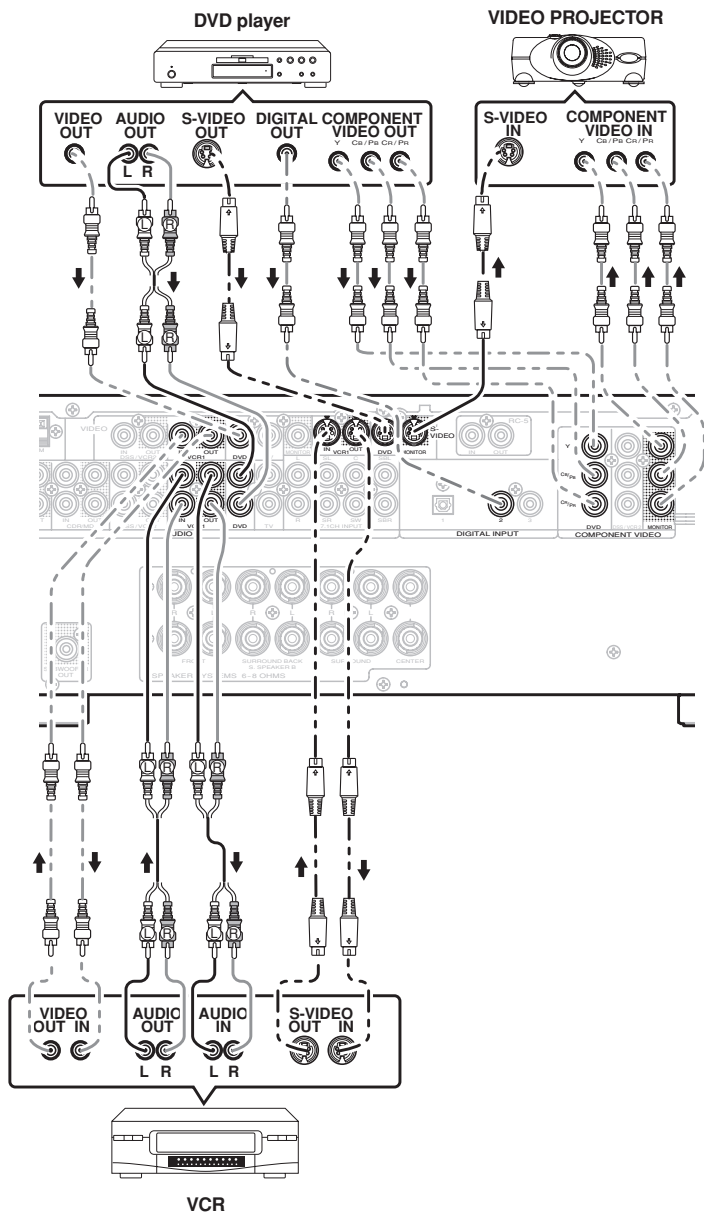

VIDEO, S-VIDEO, COMPONENT JACKS

There are 3 types of video jacks on the rear panel.

VIDEO jack

The video signal for the VIDEO jacks is the conventional composite video signal.

S-VIDEO jack

The video signal is separated into luminance (Y) and color (C) signals for the S-VIDEO jack. The S-VIDEO signals enables high-quality color reproduction. If your video component has an S-VIDEO output, we recommend to use it. Connect the S-VIDEO output jack on your video component to the S-VIDEO input jack on this unit.

Component jack

Make component video connections to a TV or monitor with component inputs to produce higher quality video images. Use a component video cable or 3 video cords to connect the component video out jacks on the SR3001 to the monitor.

Notes:

- Be sure to connect the left and right audio channels properly.
Red connectors are for the R (right) channel, and white connectors are the for L (left) channel.
- Be sure to connect the inputs and outputs of the video signals properly.
- If you connect the S-VIDEO or component signal to the S-VIDEO or component jack on this unit, it is not necessary to connect the conventional video signal to the VIDEO (composite) jack. If you use both video inputs, this unit gives priority to the S-VIDEO signal.
- Each type of video jack works independently. Signals input to the VIDEO (composite) and S-VIDEO jacks or component are output to the corresponding VIDEO (composite) and S-VIDEO or component jacks, respectively.
- You may need to setup the digital audio output format of your DVD player, or other digital source components. Refer to the instructions of the each component connected to the digital input jacks.
- There is no Dolby Digital RF input jack. Please use an external RF demodulator with a Dolby Digital decoder to connect a video disc player which has a Dolby Digital RF output jack to the digital input jack on this unit.

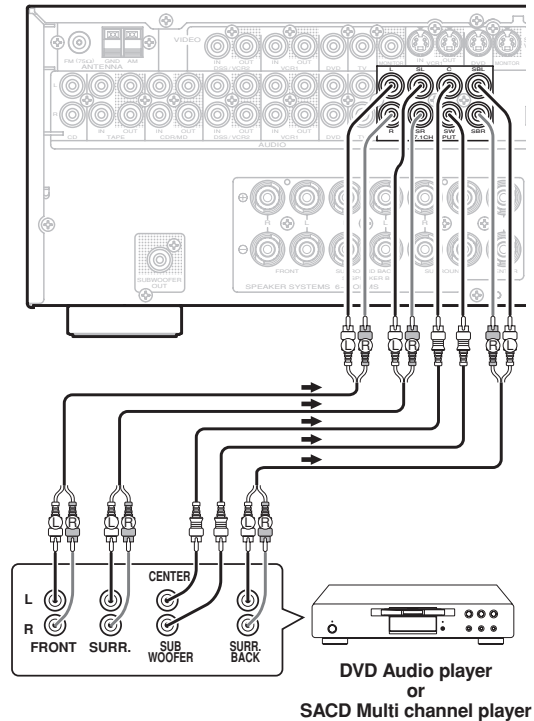

CONNECTING MULTI CHANNEL AUDIO SOURCE

The 7.1CH INPUT jacks are for multichannel audio source such as a SACD multichannel player, DVD audio player or external decoder.

If you use these jacks, switch on the 7.1CH INPUT and set the 7.1CH INPUT level by using the 7.1 channel input level menu. See page 29.

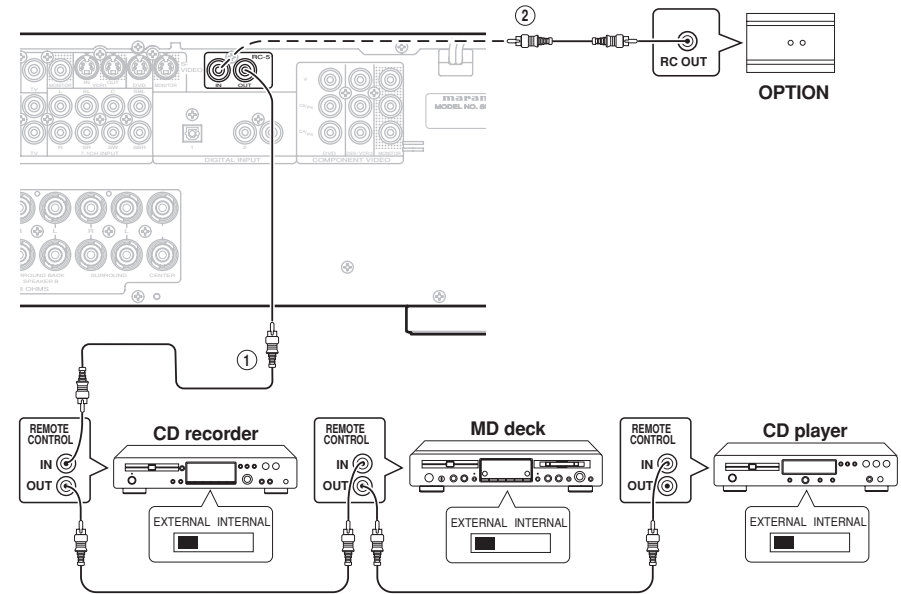

①

You can control other Marantz products through this unit with the remote control by connecting the REMOTE CONTROL terminals on each unit. The signal transmitted from the remote control is received by the remote sensor on this unit. Then the signal is sent to the connected device through this terminal. Therefore you only need to aim the remote at one unit. Also, if a Marantz power amplifier (some models excluded) is connected to one of these terminals, the power amplifier's power switch is synchronized with this unit's power switch.

Set the REMOTE CONTROL SWITCH on the units, other than the main unit to EXT.(EXTERNAL) for this feature.

②

Whenever external infrared sensors or similar devices are connected to RC-5 IN of the SR3001, be sure to always disable operation of the infrared sensor on the main unit by using the following procedure.

1. Hold down the **7.1CH INPUT** button and **MENU** button on the front panel at the same time for five seconds.
2. The setting "IR=ENABLE" is shown on the FL DISPLAY.
3. Press the ◀ or ▶ cursor button to change this to "IR=DISABLE".
4. Press the **ENTER** button. Once this setting is made, the infrared sensor on the main unit is disabled.

Note:

Be sure to set to "IR=ENABLE" when external infrared sensors or similar devices are not connected. Otherwise, the main unit will be unable to receive remote control commands.

5. To restore the original setting, perform steps 1 to 4 to set to "IR=ENABLE".

CONNECTING THE ANTENNA TERMINALS

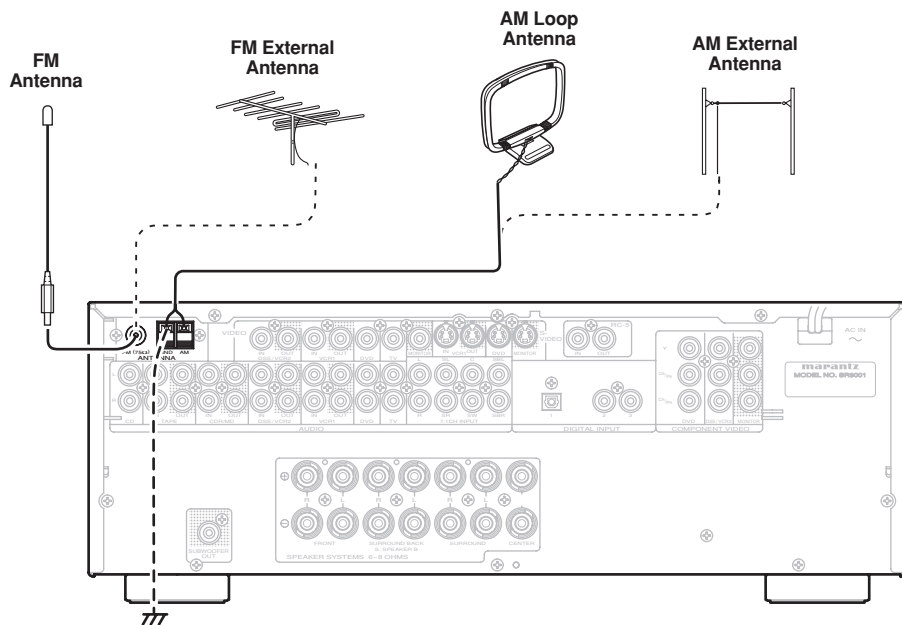

ASSEMBLING THE AM LOOP ANTENNA

1. Release the vinyl tie and take out the connection line.
2. Bend the base part in the reverse direction.
3. Insert the hook at the bottom of the loop part into the slot at the base part.
4. Place the antenna on stable surface.

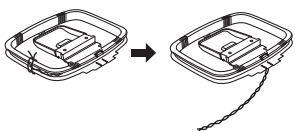

CONNECTING THE SUPPLIED ANTENNAS

Connecting the supplied FM antenna

The supplied FM antenna is for indoor use only. During use, extend the antenna and move it in various directions until the clearest signal is received. Fix it with push pins or similar implements in the position that will cause the least amount of distortion. If you experience poor reception quality, an outdoor antenna may improve the quality.

Connecting the supplied AM loop antenna

The supplied AM loop antenna is for indoor use only. Set it in the direction and position it to where you receive the clearest sound. Put it as far away as possible from the unit, televisions, speaker cables, and power cords. If you experience poor reception quality, an outdoor antenna may improve the quality.

1. Press and hold down the lever of the AM antenna terminal.
2. Insert the bare wire into the antenna terminal.
3. Release the lever.

CONNECTING AN FM OUTDOOR ANTENNA

Notes:

- Keep the antenna away from noise sources (neon signs, busy roads, etc.).
- Do not put the antenna close to power lines. Keep it well away from power lines, transformers, etc.
- To avoid the risk of lightning and electrical shock, grounding is necessary.

CONNECTING AN AM OUTDOOR ANTENNA

An outdoor antenna will be more effective if it is stretched horizontally above a window or outside.

Notes:

- Do not remove the AM loop antenna.
- To avoid the risk of lightning and electrical shock, grounding is necessary.

SETUP

After all components are connected, initial setup must be performed.

SETUP MENU SYSTEM

The SR3001 incorporates an menu on the front display, which makes various operations possible by using the **cursor** (▲, ▼, ◀, ▶) and **ENTER** buttons.

ENTER THE DESIRED MENU ITEM OF THE SETUP MENU

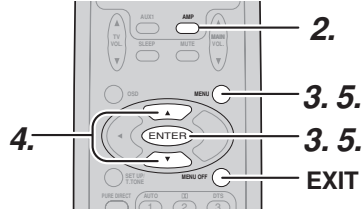
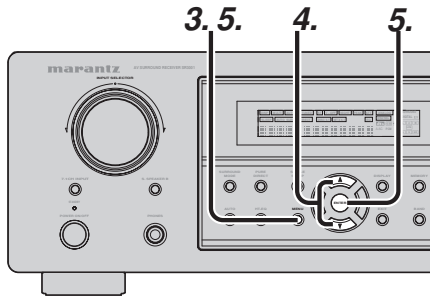

1. Turn on the unit.
2. Press the **AMP** button of the remote control.
3. Press the **MENU** button or the **ENTER** button of the remote control to enter the SETUP MENU.
4. Press the **▲** or **▼** **cursor** button to select the SETUP MENU item.
5. Press the **ENTER** button or the **MENU** button to enter the desired menu item.

After finishing all setup, press the **MENU OFF** button to exit the SETUP MENU.

MENU STRUCTURE

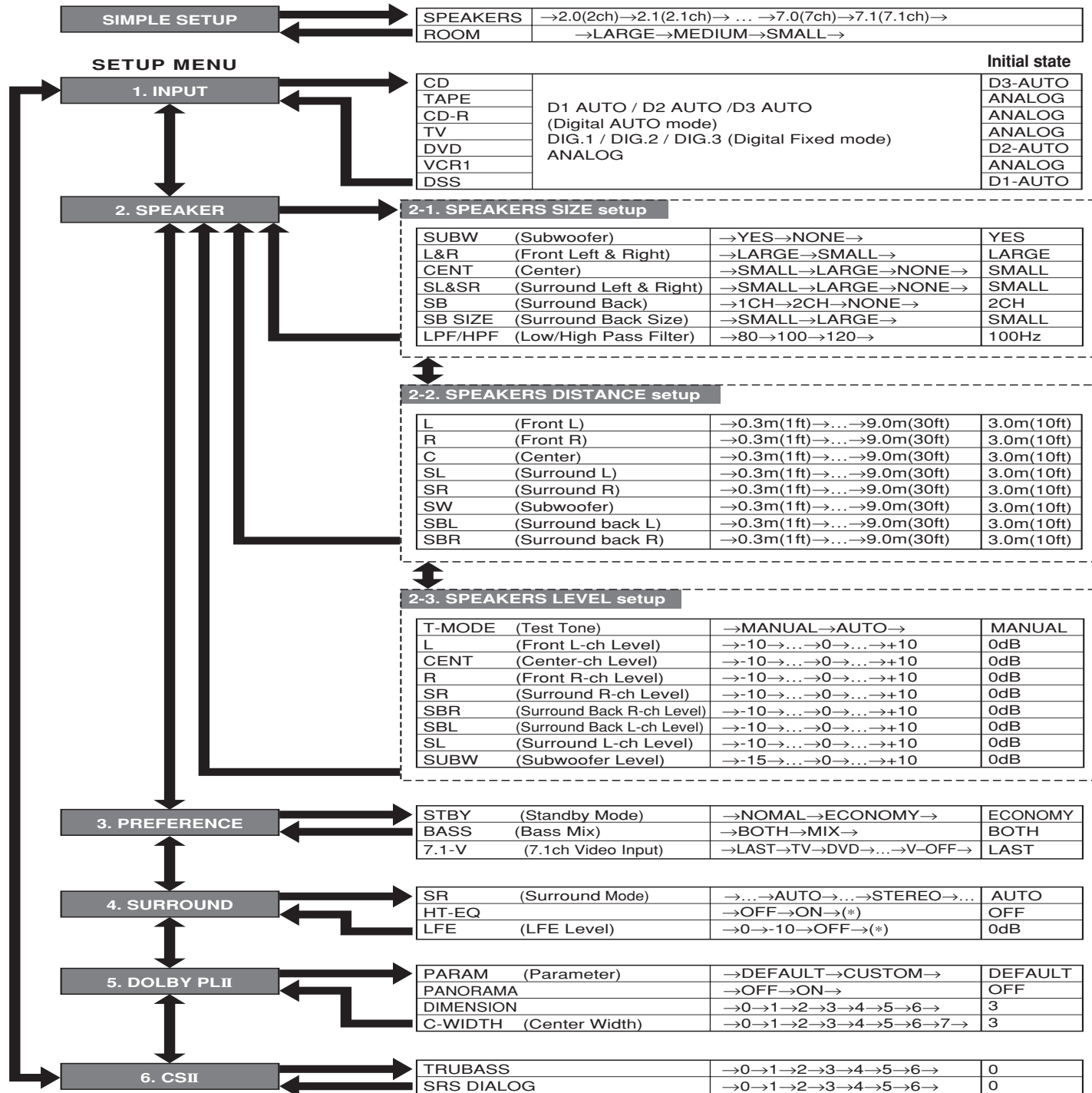

SIMPLE SETUP

You can setup the speaker conditions quickly with SIMPLE SETUP menu. In this menu, the number of speakers and speaker delay time can be set. These settings can be changed more detail in "2. SPEAKER" setup menu.

Press the **SIMPLE SETUP** button on the unit to enter this menu.

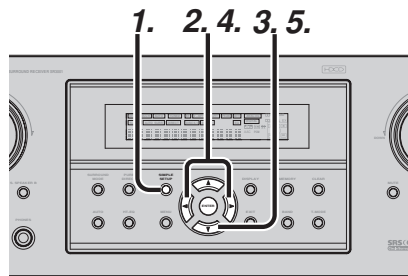

1. Press the **SIMPLE SETUP** button on the unit to enter the "SPEAKERS" menu.
2. Press ◀ or ▶ cursor button to select the speaker number.
3. Press the ▼ cursor button to enter the "ROOM" menu.
4. Press ◀ or ▶ cursor button to select the room size.
5. After finishing all setup, press the ▼ cursor button to exit the SIMPLE SETUP menu.

Note:

All Simple Setup menu is reset when the speaker setting is changed with Speaker Setup menu.

MENU STRUCTURE of Simple Setup

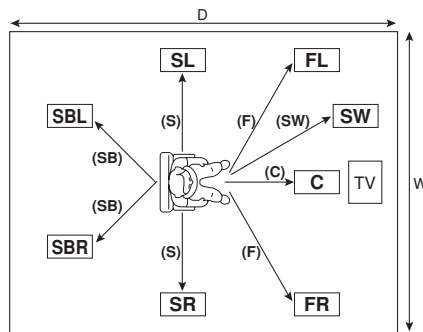
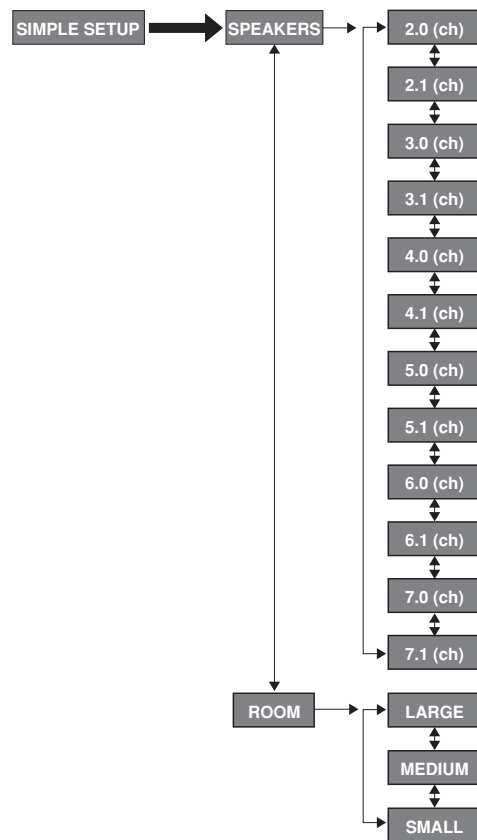

The relation of the speakers number and connected speaker

CHANNEL	Front L/R (F)	Front Center (C)	Surround L/R (S)	Surround Back L/R (SB)	Sub woofer (SW)
7.1 ch	LARGE	SMALL	SMALL	2ch	YES
7.0 ch	LARGE	SMALL	SMALL	2ch	NONE
6.1 ch	LARGE	SMALL	SMALL	1ch	YES
6.0 ch	LARGE	SMALL	SMALL	1ch	NONE
5.1 ch	LARGE	SMALL	SMALL	NONE	YES
5.0 ch	LARGE	SMALL	SMALL	NONE	NONE
4.1 ch	LARGE	NONE	SMALL	NONE	YES
4.0 ch	LARGE	NONE	SMALL	NONE	NONE
3.1 ch	LARGE	SMALL	NONE	NONE	YES
3.0 ch	LARGE	SMALL	NONE	NONE	NONE
2.1 ch	LARGE	NONE	NONE	NONE	YES
2.0 ch	LARGE	NONE	NONE	NONE	NONE

The relation of the room size and floor space

SIZE	Floor space	Width (W)	Depth (D)	Imaging Distance	
				Speaker	Distance
SMALL	10 m ²	2.7 m	3.6 m	Front (F)	6 ft. (1.8 m)
				Center (C)	5 ft. (1.5 m)
				Surround (S)	4 ft. (1.2 m)
				Surr. Back (SB)	5 ft. (1.5 m)
				Sub Woofer (SW)	5 ft. (1.5 m)
MEDIUM	16 m ²	3.6 m	4.5 m	Front (F)	7 ft. (2.1 m)
				Center (C)	6 ft. (1.8 m)
				Surround (S)	5 ft. (1.5 m)
				Surr. Back (SB)	7 ft. (2.1 m)
				Sub Woofer (SW)	6 ft. (1.8 m)
LARGE	24 m ²	4.5 m	5.4 m	Front (F)	9 ft. (2.7 m)
				Center (C)	8 ft. (2.4 m)
				Surround (S)	7 ft. (2.1 m)
				Surr. Back (SB)	8 ft. (2.4 m)
				Sub Woofer (SW)	8 ft. (2.4 m)

The relation of the room size and floor space is a roughly standard.

1. INPUT SETUP (ASSIGNABLE DIGITAL INPUT)

Four digital inputs can be assigned as the desired source.

Use this menu to select the digital input jack to be assigned to the input source.

The Input Setup consists of 6 items, which are as below.

• **D1AUTO to D3AUTO : Digital AUTO mode**

If the input signal from the selected source is digital signal, this unit chooses a digital input automatically.

• **DIG.1 to DIG.3 : Digital FIXED mode**

The SR3001 chooses a digital input regardless of a input signal from the selected source.

• **ANA : Analog mode**

Use this menu to select the digital input jack to be assigned to the input source.

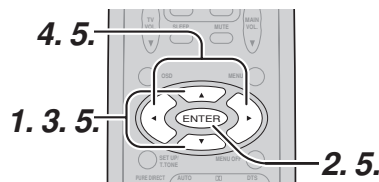
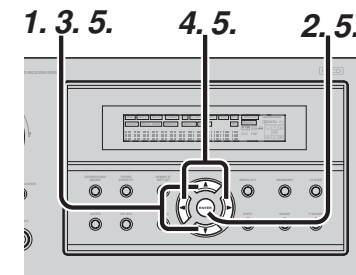

1. Select "1.INPUT" in SETUP MENU with the ▲ or ▼ cursor button.
2. Press the **ENTER** button to enter the menu.
3. Press the ▲ or ▼ cursor button to select the input source.
4. Press ◀ or ▶ cursor button to select the input function.

Select "DxAUTO", "DIG.x" or "ANA" for input sources.

- If you finish these setup, press the ▲ or ▼ cursor button to select "TO MAIN MENU" then press the **ENTER** button to return the SETUP MENU.
Or press the ◀ or ▶ cursor button to select "EXIT" then press the **ENTER** button to exit the SETUP MENU.

Notes:

- When a DTS-LD or DTS-CD is playing, this setup is not available. This is to avoid noise being generated from the analog input.
- If "Dx-AUTO" is selected and a DVD, compact disc or LD is fast forwarded during playback, decoded signals may produce a skipping sound. In such cases, change the setting to DIGITAL.
- Same digital input function cannot be set. In this case, the previous setting is set to ANALOG. Same digital input number cannot be set in Digital AUTO mode and Digital Fixed mode. For example, D1AUTO and DIG.1 are not set at same time.
- The TUNER is fixed to the analog input, and can not be selected for any digital input.

2. SPEAKER SETUP

After you have installed the SR3001, connected all the components, and determined the speaker layout, it is now time to perform the settings in the Speaker Setup menu for the optimum sound acoustics for your environment and speaker layout. Before you perform the following settings, it is important that you first determine the following characteristics:

2-1. SPEAKERS SIZE

When setting the speaker size in the SPEAKER SIZE sub-menu, use the guidelines given below.

Large:

The complete frequency range for the channel you are setting will be output from the speaker.

Small:

Frequencies of the channel you are setting lower than approx. 100Hz will be output from the subwoofer.

If the Subwoofer is set to "NONE" and the front speakers are set to "Large," then the sound may be output from both the left and right speakers.

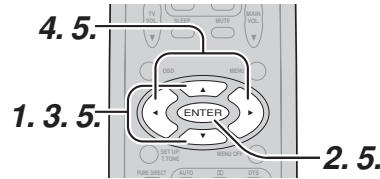
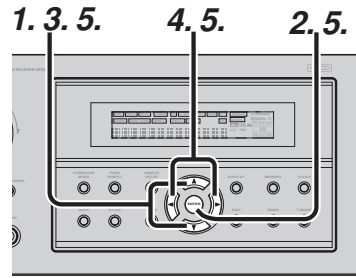

- Select "2.SPEAKER" in SETUP MENU with ▲ or ▼ cursor button,
- Press the **ENTER** button to enter the menu. The first sub-menu item is "2-1.Speakers Size" setup.
- Press ▲ or ▼ cursor button to select the each speaker.
- Press ◀ or ▶ cursor button to select the setting of size to each speaker.
- If you finish these setup, press the ▲ or ▼ cursor button to select "NEXT".
- Press the **ENTER** button to enter the next "2-2. Speakers Distance" setup.
Or press the ◀ or ▶ cursor button to select "EXIT" then press the **ENTER** button to exit the SETUP MENU.
Or press the ◀ or ▶ cursor button to select "TO MAIN MENU" then press the **ENTER** button to return the SETUP MENU.

MENU STRUCTURE of Speakers Size setup

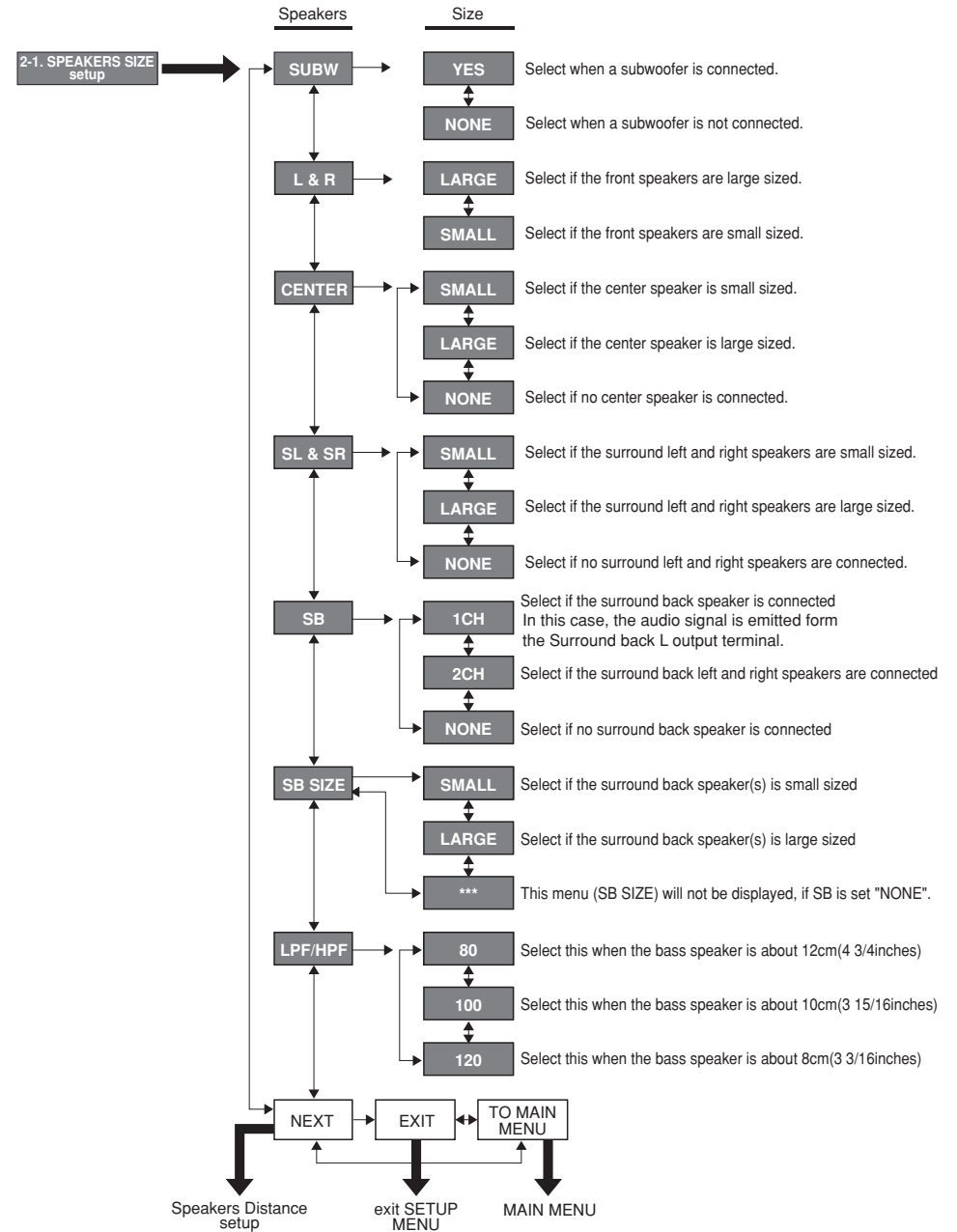

2-2. SPEAKERS DISTANCE

Use this parameter to specify the distance of each speaker's position from the listening position. The delay time is automatically calculated according to these distances.

Begin by determining the ideal or most commonly used seating position in the room.

This is important for the timing of the acoustics to create the proper sound space that the SR3001 and today's sound systems are able to produce.

Note that the speakers that you selected "None" for in the Speaker Config sub-menu will not appear here.

1. 3. 5. 4. 5. 2. 5.

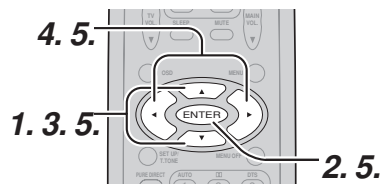
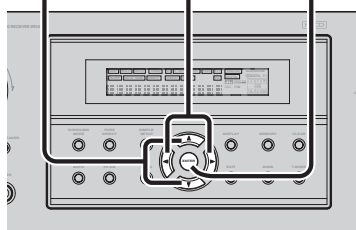

1. Enter to the "2-2. Speakers Distance" from the previous "2-1. Speakers Size".
2. Press ▲ or ▼ cursor button to select the each speaker.
3. Press ◀ or ▶ cursor button to set the distance from your listening position for each speaker.
4. After finishing the Speaker Distance setup, press the ▲ or ▼ cursor button to select "NEXT".
5. Press the **ENTER** button to enter the next "Speaker Level" setup.

Or press the ◀ or ▶ cursor button to select "EXIT" then press the **ENTER** button to exit the SETUP MENU.

Or press the ◀ or ▶ cursor button to select "TO MAIN MENU" then press the **ENTER** button to return the SETUP MENU.

Or press the ◀ or ▶ cursor button to select "RETURN" then press the **ENTER** button to return the previous "2-2. Speakers Distance" setup.

L&R :

Set the distance from the front left and right speakers to your normal listening position between 1 and 30 feet in 1.0 foot interval (0.3 to 9 meters in 0.3-meter intervals).

C :

Set the distance from the center speaker to your normal listening position between 1 and 30 feet in 1.0 foot interval (0.3 to 9 meters in 0.3-meter intervals).

SL&SR:

Set the distance from the surround left and right speaker to your normal listening position between 1 and 30 feet in 1.0 foot interval (0.3 to 9 meters in 0.3-meter intervals).

SW :

Set the distance from the subwoofer to your normal listening position between 1 and 30 feet in 1.0-foot intervals (0.3 to 9 meters in 0.3-meter intervals).

SB:

Set the distance from a surround back speaker to your normal listening position between 1 and 30 feet in 1.0-foot intervals (0.3 to 9 meters in 0.3-meter intervals).

Note:

Speakers that you selected "No" or "None" for in the Speaker Size menu will not appear.

MENU STRUCTURE of Speakers Distance setup

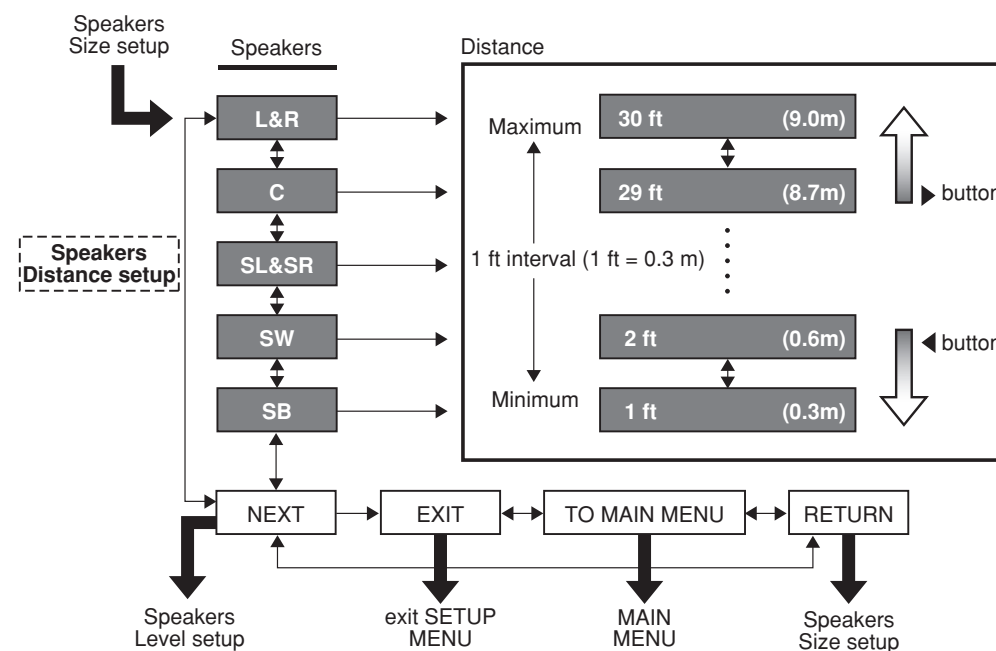

2-3. SPEAKERS LEVEL SETTING WITH TEST TONE

Here you will set the volume for each speaker so that they are all heard by the listener at the same level. Moreover, if the **T.TONE** button is pressed, unit can enter into this menu directly.

Note:

The speaker level settings are not available in 7.1 Channel Input mode, CS mode and Multi Channel Stereo mode.

T(TEST) MODE :

Selects **"MANUAL"** or **"AUTO"** for generating mode of test tone ◀ or ▶ cursor button.

If you select **"AUTO"** by pressing the ▼ button, the test tone will be cycled through in a circular pattern which is L (Left) → C (Center) → R (Right) → SR (Surround Right) → SBR (Surround Back Right) → SBL (Surround Back Left) → SL (Surround Left) → SW (Subwoofer) → L →.. increments of 2 seconds for each channel.

Using the ◀ and ▶ cursor buttons, adjust the volume level of the noise from the speaker so that it is the same level for all speaker.

Press the **ENTER** button, you can stop the test tone mode. Or press the ◀ or ▶ cursor button to select **"EXIT"** then press the **ENTER** button to exit the **SETUP MENU**.

Or press the ◀ or ▶ cursor button to select **"RETURN"** then press the **ENTER** button to return the previous **"2-2. Speakers Distance"** setup.

If you select **"MANUAL"**, adjust the output level of each speaker as follow.

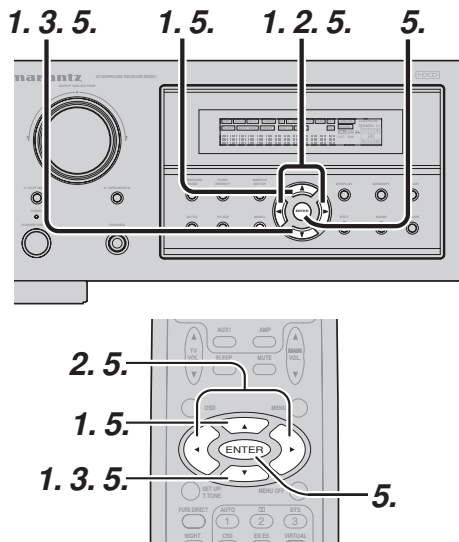

1. When you select **"MANUAL"** in T-MODE menu by pressing the ◀ or ▶ button, this unit will emit a pink noise from the front left speaker. At this time, adjust the desired level of the master volume. Remember the level of this noise and then press the ▼ button. This unit will emit the pink noise from the center speaker.
2. Using the ◀ and ▶ cursor buttons, adjust the volume level of the noise from the center speaker so that it is the same level as the front left speaker (Note that this can be adjusted to any level between -10 and +10 dB in 1dB intervals).

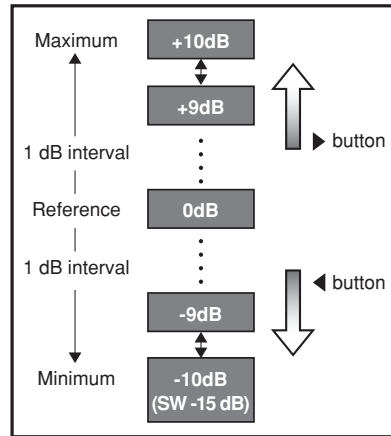

3. Press the ▼ cursor button again. This unit will now emit the pink noise from the front right speaker.
4. Repeat steps 2 and 3 above for the front right and other speakers until all speakers are adjusted to the same volume level.
5. Press the **ENTER** button, you can stop the test tone mode. Or press the ◀ or ▶ cursor button to select **"EXIT"** then press the **ENTER** button to exit the **SETUP MENU**.
Or press the ◀ or ▶ button to select **"RETURN"** then press the **ENTER** button to return the previous **"2-2. Speakers Distance"** setup.

Notes:

- Speakers that you selected **"None"** for in the Speaker Size Setup menu will not appear.
- The setup level for each channel is memorized for reproduction in all surround mode by this method exclude CS mode, Multi channel stereo mode and 7.1 ch input mode.
- To adjust the speaker levels for 7.1-channel input sources, you will need to use the 7.1CH Level Input setup menu.

MENU STRUCTURE of Speaker Level setup

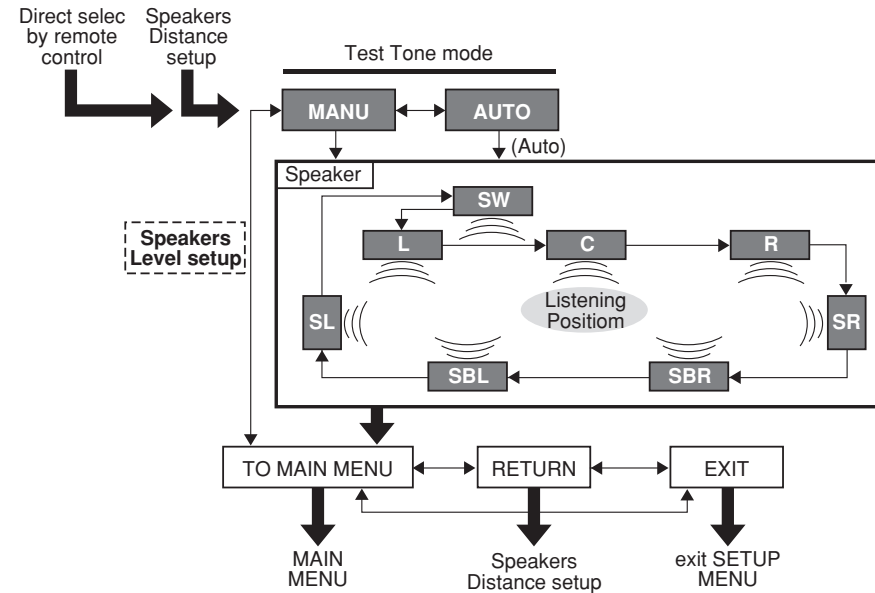

2-4. SPEAKERS LEVEL SETTING WITHOUT TEST TONE

Channel level (speaker level) can be adjusted without using test tone.

Note:

Four channel level settings can be memorized for reproduction: the 7.1 ch input mode, CS mode, Multi channel stereo mode, and all other surround modes, respectively.

1. Set the surround mode or 7.1 ch input mode which you want to adjust the channel level.
2. Press the **CH.SEL** button on the remote.
3. Select the desired channel (speaker) with the ◀ or ▶ cursor buttons.
4. Adjust the level with the ▲ or ▼ cursor buttons.
5. After completing the setup, press the **CH.SEL** button again.

3. PREFERENCE

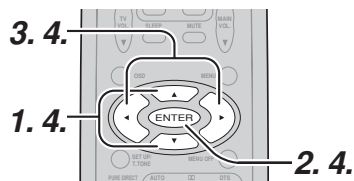
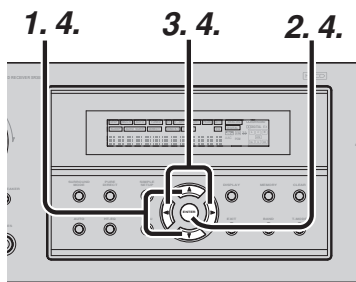

1. Select "3. PREFERENCE" in SETUP MENU with ▲ or ▼ cursor button.
2. Press the **ENTER** button.
3. Press ▲ or ▼ cursor button to select desired item.
4. Press ◀ or ▶ cursor button to set the mode.

MENU STRUCTURE of PREFERENCE setup

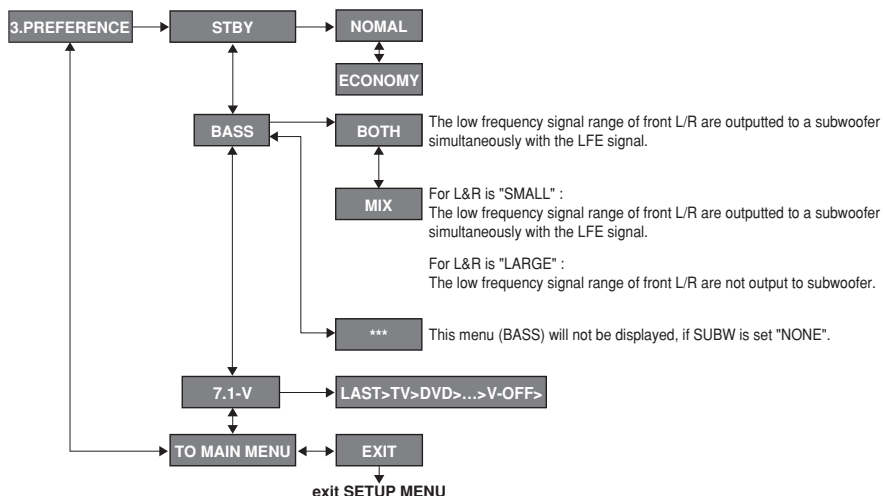

STANDBY MODE:

When this function is set to "ECONOMY", you can reduce the power consumption when the unit is in the standby mode.

5. When you select "TO MAIN MENU" by pressing the ▲ or ▼ button, you can return the SETUP MENU by pressing the **ENTER** button.
Or press the ◀ or ▶ cursor button to select "EXIT" then press the **ENTER** button to exit the SETUP MENU.

BASS MIX

- The bass mix setting is only valid when "LARGE" is set for the front speakers and "YES" is set for the subwoofer at stereo playback.
- When the "BOTH" is selected, the low frequency signal range of "LARGE" are produced simultaneously from those channels and the subwoofer channel.
When actual low frequency sound volume is weak depending on room size, use this function to fill low frequency sound equally in the room.
- When "Mix" is selected, subwoofer output is determined depending on the speaker sizes for each channels. If the front speaker size is set to "Large", subwoofer output is only the LFE signal contained in Dolby Digital or DTS processed signals.

Note:

When Front speaker is set "SMALL", then BASS MIX is set "MIX". (The display appears "BASS MIX = ***".)

4. SURROUND

This sub menu is to adjust channel levels for each surround setting groups. There are three surround setting groups shown below. Therefore if settings for a surround mode are changed, settings for all other surround modes in the same group are also changed.

Surround setting group

- 1 : AUTO, DOLBY, DTS, EX/ES, VIRTUAL, STEREO
- 2 : Multi-ch stereo
- 3 : CS II

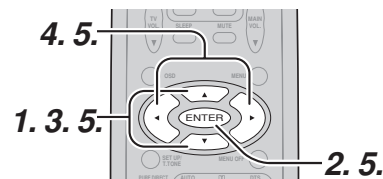
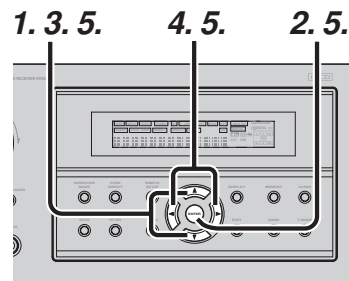

1. Select "4. SURROUND" in SETUP MENU with ▲ or ▼ cursor button.
2. Press the **ENTER** button.
3. To select a desired item, press ▲ or ▼ cursor button.
4. Using the ◀ or ▶ cursor button to select the mode or adjust the volume level of each speaker.
5. When you select "TO MAIN MENU" by pressing the ▲ or ▼ button, you can return the SETUP MENU by pressing the **ENTER** button.
Or press the ◀ or ▶ cursor button to select "EXIT" then press the **ENTER** button to exit the SETUP MENU.

SR(SURR-MODE) :

Select the desired surround mode with ◀ or ▶ cursor button.

- If one of the following modes is selected, all other modes are also set to the same. AUTO, DOLBY, DTS, EX/ES, VIRTUAL, STEREO.

HT-EQ :

Select to active the HT-EQ with the ◀ or ▶ cursor buttons.

The tonal balance of a film soundtrack will be excessively bright and harsh when played back over audio equipment in the home. This is because film soundtracks were designed to be played back in large movie theater environments.

Activating the HT-EQ feature when watching a film made for movie theaters corrects this and restores the correct tonal balance.

The HT-EQ feature can be activated only while in Dolby Pro Logic Mode, or while decoding Dolby Digital or DTS encoded material.

LFE LEVEL :

Select the output level of the LFE signal included in the Dolby Digital signal or the DTS signal.

Select 0 dB, -10 dB or OFF with the ◀ or ▶ cursor buttons.

When you select "TO MAIN MENU" by pressing the ▲ or ▼ button, you can return the SETUP MAIN MENU by pressing the **ENTER** button.

MENU STRUCTURE of SURROUND setup

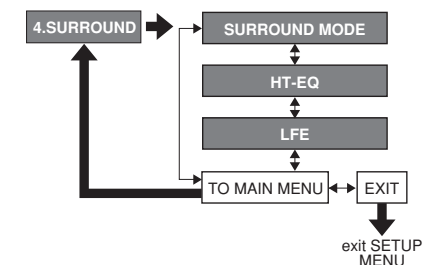

5. PL II (DOLBY PRO LOGIC II) MUSIC PARAMETER

Pro Logic II-Music mode creates a rich and enveloping surround ambience from stereo sources such as CDs.
In this mode, SR3001 includes three controls to fine-tune the soundfield as follows.

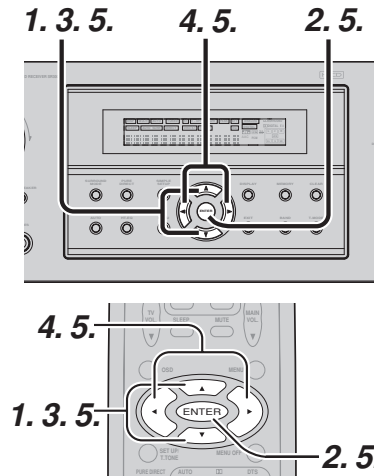

1. Select "5. PL II MUSIC PARAMETER" in SETUP MENU with ▲ or ▼ cursor button.
2. Press the **ENTER** button to enter the menu.
3. Press ▲ or ▼ cursor button to select a desired item.
4. Press ◀ or ▶ cursor button to select the mode or set the level.
5. When you select "TO MAIN MENU" by pressing the ▲ or ▼ button, you can return the SETUP MENU by pressing the **ENTER** button.

Or press the ◀ or ▶ cursor button to select "EXIT" then press the **ENTER** button to exit the SETUP MENU.

PANORAMA:

Select the Panorama mode On or Off with ◀ or ▶ cursor button.
Panorama wraps the sound of the front left and right speakers around you for an exciting perspective.

DIMENSION:

Set the Dimension level between 0 and 6 level in 1 level interval with ◀ or ▶ cursor button.
Adjust the soundfield either towards the front or towards the rear.
This can be useful to help achieve a more suitable balance from all the speakers with certain recordings.

C WIDTH:

Set the Center width level between 0 and 7 level in 1 level interval with ◀ or ▶ cursor button.
Center Width allows you to gradually spread the center channel sound into the front left and right speakers.
At its widest setting, all the sound from the center is mixed into the left and right.
This control may help achieve a more spacious sound or a better blend of the front image.
If "NONE" was selected for the Center speaker setting in the Speaker size, then this setting will not appear.

MENU STRUCTURE of PRO LOGIC II setup

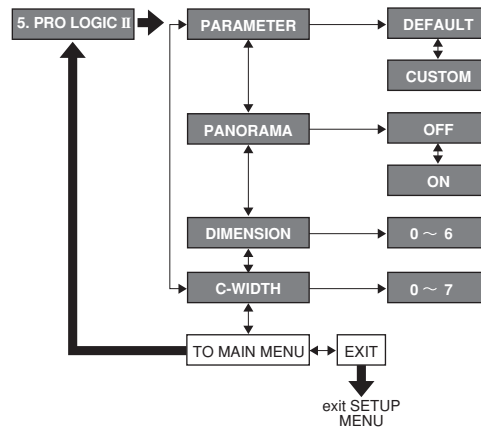

6. CS II (CIRCLE SURROUND II)

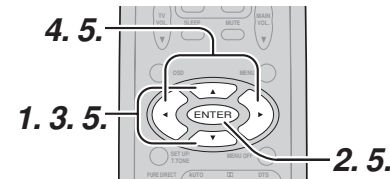
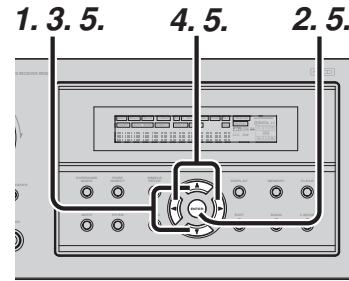

1. Select "6. CS II" in SETUP MENU with ▲ or ▼ cursor button.
2. Press the **ENTER** button to enter this menu.
3. Press ▲ or ▼ cursor button to select desired item.
4. Press ◀ or ▶ cursor button to set the level.
5. When you select "TO MAIN MENU" by pressing the ▲ or ▼ button, you can return the SETUP MENU by pressing the **ENTER** button.

Or press the ◀ or ▶ cursor button to select "EXIT" then press the **ENTER** button to exit the SETUP MENU.

TRUBASS:

Set the TRUBASS level between 0 and 6 level in 1 level interval with ◀ or ▶ cursor button.
TRUBASS produced by the speakers to be an octave below the actual physical capabilities of the speakers adding exciting, deeper bass effects.

SRS DIALOG:

Set the SRS DIALOG level between 0 and 6 level in 1 level interval with ◀ or ▶ cursor button.
This can be popped out of the surround audio effects allowing the listener to easily discern what the actors say.
If "NONE" was selected for the Center speaker setting in the Speaker size, then this setting will not appear.

MENU STRUCTURE of CS II setup

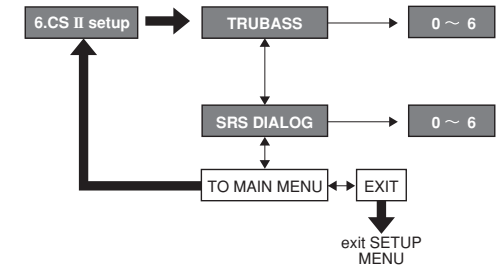

BASIC OPERATION

(PLAY BACK)

SELECTING AN INPUT SOURCE

Before you can listen to any input media, you must first select the input source on the SR3001.

Example : DVD

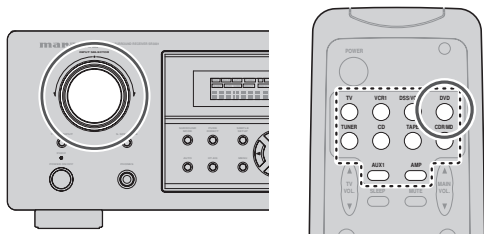

To select DVD, turn the **INPUT FUNCTION SELECTOR** knob on the front panel or simply press the **DVD** button on the remote.

After you have selected DVD, simply turn on the DVD player and play the DVD.

- The input name will appear in the display on the front panel.
- As the input is changed, the SR3001 will automatically switch to the digital input, surround mode, attenuation, and night mode status which were entered during the configuration process for that source.
- When an audio source is selected, the last video input used remains routed to the **VCR1 & DSS/VCR2** Outputs and **Monitor** Outputs. This permits simultaneous viewing and listening to different sources.
- When a Video source is selected, the video signal for that input will be routed to the **Monitor Outputs** jacks and will be viewable on a TV monitor connected to the SR3001.
- When a Video source is selected, the video signal for that input will be routed to the **Monitor Outputs** jacks and will be viewable on a TV monitor connected to the SR3001.

SELECTING THE SURROUND MODE

Example : AUTO SURROUND

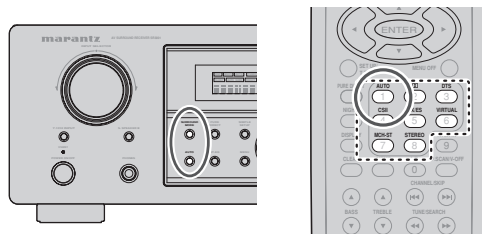

To select the surround mode during playback, press the **SURROUND MODE** button on the front panel or the **Surround mode** buttons on the remote.

ADJUSTING THE MAIN VOLUME

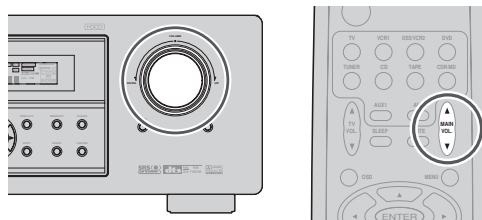

Adjust the volume to a comfortable level using the **VOLUME** control knob on the front panel or **VOL ▲ / ▼** buttons on the remote.

To increase the volume, turn the **VOLUME** knob clockwise or press **VOL ▲** button on the remote, to decrease the volume, turn counterclockwise or press **VOL ▼** button on the remote.

Notes:

- The volume can be adjusted within the range of $-\infty$ to 18 dB, in steps of 1 dB.
- However, when the channel level is set as described on page 20, if the volume for any channel is set at +1 dB or greater, the volume cannot be adjusted up to 18 dB.
(In this case the maximum volume adjustment range is "18 dB - Maximum value of channel level")

ADJUSTING THE TONE (BASS & TREBLE) CONTROL



During a listening session you may wish to adjust the Bass and Treble Control to suit your listening tastes or room acoustics.

(Using the remote control unit)

To adjust the bass effect, press **BASS▲** or **BASS▼** on the remote.

To adjust the treble effect, press **TREBLE▲** or **TREBLE▼** on the remote.

Note:

The tone control function can work in the **AUTO Surround, Stereo, Dolby PLIIX, DTS, DTS-ES, and Multi Ch. Stereo** mode.

TEMPORARILY TURNING OFF THE SOUND

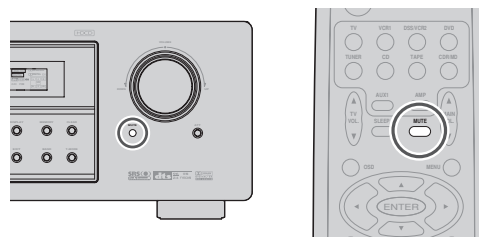

To temporarily silence all speaker outputs such as when interrupted by a phone call, press the **MUTE** button on the front panel or **MUTE** button on the remote.

This will interrupt the output to all speakers and the head-phone jack, but it will not affect any recording or dubbing that may be in progress.

When the system is muted, the display will show **"MUTE"**.

Press the **MUTE** button again to return to normal operation.

USING THE SLEEP TIMER

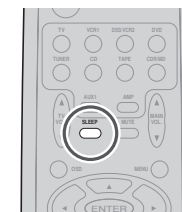

To program the SR3001 for automatic standby, press the **SLEEP** button on the remote.

Each press of the button will increase the time before shut down in the following sequence.

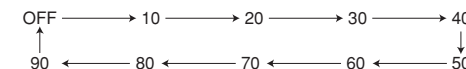

The sleep time will be shown for a few seconds in the display on the front panel, and it will count down until the time has elapsed.

When the programmed sleep time has elapsed, the unit will automatically turn off.

Note that the **SLEEP** indicator on the display will illuminate when the Sleep function is programmed.

To cancel the Sleep function, press the **SLEEP** button until the display shows **"SLEEP OFF"** and the **SLEEP** indicator will disappear.

NIGHT MODE



Press the **NIGHT** button on the remote to turn on the **NIGHT** mode.

Selecting the **Night Mode ON** is effective in **Dolby Digital** only, and it compresses the dynamic range. This softens loud passages such as sudden explosions, to help prevent disturbing others late at night.

To turn off the **Night mode**, press the **NIGHT** button again.

SURROUND MODE

The SR3001 is equipped with many surround modes. These are provided to reproduce a variety of surround sound effects, according to the content of the source to be played.

The available surround modes may be restricted depending on the input signal and speaker setup.

AUTO

When this mode is selected, the receiver determines whether the digital input signal is Dolby Digital, Dolby Digital Surround EX, DTS, DTS-ES, DTS 96/24 or PCM-audio.

Surround EX & DTS-ES will operate for multichannel source that has a Dolby Digital Surround EX or DTS-ES auto trigger flag in the digital signal.

When a Dolby Digital or DTS signal is input, the number of channels for which the corresponding signal is encoded will be played.

Inputting a Dolby Digital two channel signal with Dolby surround status automatically subjects that signal to Pro Logic IIx movie processing before play.

PCM 96 kHz source material can be played in this mode.

Notes:

- When you use this mode with certain DVD and CD players, performing operations such as “Skip” or “Stop” may momentarily interrupt the output.
- When the signal is not decoded, the mode is changed to AUTO mode automatically. Refer to page 26 to confirm the available decoding mode.

DD MODE

(Dolby Digital, Pro Logic IIx MOVIE, Pro Logic IIx MUSIC, Pro Logic IIx GAME, Pro Logic)

This mode is used with source materials encoded in Dolby Digital and Dolby Surround.

DOLBY DIGITAL

This mode is enabled when playing source materials encoded in Dolby Digital.

Playing multichannel encoded 6.1 or 7.1-channel Dolby Digital sources provides five main audio channels (left, center, right, surround left and surround right) and Low Frequency Effect channel.

Dolby Digital EX decoding is not available in this mode.

Dolby Pro Logic IIx brings the excitement of surround sound to any stereo mix, while making existing Dolby Surround mixes sound more like discrete 6.1 or 7.1-channel Surround sound.

Dolby Pro Logic IIx has 3 modes. Please see below.

Pro Logic IIx MOVIE

This mode provides 6.1 or 7.1 channel surround sound from Dolby Surround encoded stereo movie sound tracks.

Pro Logic IIx MUSIC

This mode provides 6.1 or 7.1 channel surround sound from conventional stereo sources, analog or digital, such as CD, Tape, FM, TV, Stereo VCR, etc.

Pro Logic IIx GAME

Game mode restores the impact low-frequency surround effects by routing them to the system's subwoofer.

Pro Logic

This mode emulated original Dolby Pro Logic decoding (3/1 surround) suit for Dolby Surround encoded stereo movie soundtracks.

Notes:

- Pro Logic IIx mode will decode as Pro Logic II mode when the SURROUND BACK SPEAKER is set NONE in SPEAKER SETUP menu. (See SPEAKER SETUP, page 18)
- Pro Logic IIx mode is available for a 2ch input signal which is encoded in Dolby Digital or PCM format.
- PCM-audio signals can be subjected to Pro Logic processing when the sampling frequency is 32 kHz, 44.1 kHz or 48 kHz.

EX/ES

This mode provides 6.1 channel surround for DOLBY DIGITAL EX, DTS-ES encoded source material such as DVD.

This mode cannot be used when an analog input has been selected.

Dolby Digital EX

In a movie theater, film soundtracks that have been encoded with Dolby Digital surround EX technology are able to reproduce an extra channel which has been added during the mixing of the program.

This channel, called Surround Back, places sounds behind the listener in addition to the currently available front left, front center, front right, surround right, surround left and subwoofer channels.

This additional channel provides the opportunity for more detailed imaging behind the listener and brings more depth, spacious ambience and sound localization than ever before.

Dolby Digital EX is not available in the system without surround back speaker(s).

DTS-ES (Discrete 6.1, Matrix 6.1)

DTS-ES adds the surround center channel audio to the DTS 5.1-channel format to improve the acoustic positioning and makes acoustic image movement more natural with the 6.1-channel reproduction.

This receiver incorporates a DTS-ES decoder, which can handle DTS-ES Discrete-encoded and DTS-ES Matrix-encoded program sources from DVD, etc..

DTS-ES Discrete 6.1 features digital discrete recording of all channels including the surround back channel(s) and higher quality of audio reproduction.

DTS-ES is not available in the system without a surround back speaker.

dts MODE

(dts, Neo:6 Cinema, Neo:6 Music)

This mode is for DTS encoded source materials such as LASER DISC, CD, and DVD. Neo:6 is for some 2 channel sources.

dts : This mode is enabled when playing source materials encoded in dts multichannel.

Playing multichannel encoded 5.1-channel dts sources provides five main audio channels (left, center, right, surround left and surround right) and Low Frequency Effect channel.

dts-ES decoding is not available in this mode.

The DTS mode cannot be used when an analog input has been selected.

Neo:6 Cinema, Neo:6 Music

This mode decodes 2-channel signals into 6-channel signals using high-accuracy digital matrix technology.

The DTS Neo:6 decoder has near-discrete properties in the frequency characteristics of the channels as well as in channel separation.

According to the signals to be played back, DTS Neo:6 uses either the Neo:6 CINEMA mode optimized for movie playback or the Neo:6 MUSIC mode optimized for music playback.

Notes:

- Neo:6 mode is available to 2ch input signals which are encoded in Dolby Digital or PCM format.
- PCM-audio signals can be subjected to Pro Logic processing when the sampling frequency is 32 kHz, 44.1 kHz or 48 kHz.

MULTI CH. ST

This mode is used to create a wider, deeper and more natural soundstage from two channel source material.

This is done by feeding the left channel signal to both left front and left surround speaker and the right channel signal to both right front and right surround speaker. Additionally, the center channel reproduces a mix of the right and left channel.

CIRCLE SURROUND II (CSII-CINEMA, CSII-MUSIC, CSII-MONO)

Circle Surround is designed to enable multichannel surround sound playback of non-encoded and multichannel encoded material.

Backward compatibility provides listeners with up to 6.1 channels of surround performance from entire collection of music and film, including broadcast, videotape and stereo recorded music.

Depending on source material, you can select **CSII-Cinema** mode, **CSII-Music** mode or **CSII-Mono** mode.

Notes:

- CS II mode is available for 2ch input signals which are encoded in Dolby Digital or PCM format.
- PCM-audio signals can be subjected to Pro Logic processing when the sampling frequency is 32 kHz, 44.1 kHz or 48 kHz.

VIRTUAL

This mode creates a virtualized surround sound experience from a two-speaker (front L and R) playback system playing any multichannel audio source (such as found on DVDs and digital broadcasts), including Dolby Digital, Dolby Pro Logic or DTS.

STEREO

This mode bypasses all surround processing. In stereo program sources, the left and right channels play normally when PCM-audio or analog stereo is input.

With Dolby Digital and DTS sources, the 5.1 multichannels are converted to two channel stereo. 96 kHz PCM source material can be played back in stereo mode.

PURE - DIRECT

In the Pure Direct mode, the tone control circuit and bass management configuration are bypassed for full range frequency response and the purist audio reproduction.

96 kHz PCM source material can be played back in this mode.

Notes:

- Internal speaker size is setup to front L/R = LARGE, Center = LARGE, Surround L/R = LARGE and Subwoofer = YES automatically. Tone controls and additional processing are also defeated.
- When you use this mode with certain DVD and CD players, performing operations such as "Skip" or "Stop" may momentarily interrupt the output.

CAUTION***NOTE for DTS signal***

- * Connected DVD-player, laser-disc player or CD-player needs to support DTS-digital output. You may not be able to play some DTS source signals from certain CD players and LD players even if you connect the player to the SR3001 digitally. This is because the digital signal has been processed (such as the output level, sampling frequency, or frequency response) and the SR3001 cannot recognize the signal as DTS data.
- * Depending on the player used, DTS play may produce a short noise. This is not a malfunction.
- * While signals from DTS-laser disc or CD are playing in another Surround mode, you cannot switch to digital input or from digital input to analog input by INPUT SETUP in SETUP MAIN MENU or the A/D button.
- * The outputs for the VCR 1 OUT, DSS/VCR 2 OUT, TAPE OUT, and CD-R OUT output analog audio signals. Do not record from CDs or LDs that support DTS using these outputs. If you do, the DTS-encoded signal will be recorded as noise.

NOTE for Dolby Digital Surround EX signal

- * When playing Dolby Digital Surround EX-encoded software in 6.1 channels, it is required to set the EX/ES mode.
- * Note that some of Dolby Digital Surround EX-encoded software does not contain the identification signal. In this case, set the EX/ES mode manually.

NOTE for 96kHz PCM audio

- * AUTO, Pure- DIRECT, and STEREO modes can be used when playing PCM signals with a sampling frequency of 96 kHz (such as from DVD-Video discs that contain 24 bit, 96 kHz audio). If such signals are input during playback in one of the other surround modes, output from SR3001 will be muted.
- * Certain DVD player models inhibit digital output. For details, refer to the player's operation manual.
- * Some DVD formatted discs feature copy protection. When using such disc, 96 kHz PCM signal is not output from the DVD player. For details, refer to the player's operation manual.

NOTE for HDCD signal

- * HDCD is effective only at the time of digital input.
- * AUTO, PURE DIRECT, and STEREO modes can be used when playing HDCD signals (such as from CD discs that contain HDCD).
- * You may not be able to play some HDCD source signals from certain CD players if you connect the player to the SR3001 digitally. This is because the digital signal has been processed (such as the output level, sampling frequency, or frequency response) and the SR3001 cannot recognize the signal as HDCD data.

The relation between the selected surround mode and the input signal

The surround mode is selected with the surround mode selector on SR3001 or the remote control unit. However, the sound you hear is subject to the relationship between the selected surround mode and input signal. That relationship is as follows;

Surround Mode	Input Signal	Decoding	Output Channel					Front information display		
			L/R	C	SL SR	SBL SBR	SubW	Signal format indicators	Channel status	
AUTO	Dolby Surr. EX	Dolby Digital EX	○	○	○	○	○	DD DIGITAL	L, C, R, SL, SR, S, LFE	
	Dolby D (5.1ch)	Dolby Digital 5.1	○	○	○	-	○	DD DIGITAL	L, C, R, SL, SR, LFE	
	Dolby D(2ch)	Dolby Digital 2.0	○	-	-	-	-	DD DIGITAL	L, R	
	Dolby D (2ch Surr)	Pro Logic IIx movie	○	○	○	○	-	DD DIGITAL , DD SURROUND	L, R, S	
	DTS-ES	DTS-ES	○	○	○	○	○	dts, ES	L, C, R, SL, SR, S, LFE	
	DTS 96/24	DTS 96/24	○	○	○	-	○	dts 96/24	L, C, R, SL, SR, LFE	
	DTS (5.1ch)	DTS 5.1	○	○	○	-	○	dts	L, C, R, SL, SR, LFE	
	PCM(Audio)	PCM (Stereo)	○	-	-	-	-	PCM	L, R	
	PCM 96kHz	PCM (96kHz Stereo)	○	-	-	-	-	PCM	L, R	
	HDCD	PCM (Stereo)	○	-	-	-	-	PCM HDCD	L, R	
	Analog	Stereo	○	-	-	-	-	ANALOG	-	
PURE-DIRECT	Dolby D Surr. EX	Dolby Digital EX	○	○	○	○	○	DD DIGITAL	L, C, R, SL, SR, S, LFE	
	Dolby D (5.1ch)	Dolby Digital 5.1	○	○	○	-	○	DD DIGITAL	L, C, R, SL, SR, LFE	
	Dolby D (2ch)	Dolby Digital 2.0	○	-	-	-	-	DD DIGITAL	L, R	
	Dolby D (2ch Surr)	Pro Logic IIx movie	○	○	○	○	-	DD DIGITAL , DD SURROUND	L, R, S	
	DTS-ES	DTS-ES	○	○	○	○	○	dts, ES	L, C, R, SL, SR, S, LFE	
	DTS 96/24	DTS 96/24	○	○	○	-	○	dts 96/24	L, C, R, SL, SR, LFE	
	DTS (5.1ch)	DTS 5.1	○	○	○	-	○	dts	L, C, R, SL, SR, LFE	
	PCM (Audio)	PCM (Stereo)	○	-	-	-	-	PCM	L, R	
	PCM 96kHz	PCM (96kHz Stereo)	○	-	-	-	-	PCM	L, R	
	HDCD	PCM (Stereo)	○	-	-	-	-	PCM HDCD	L, R	
	Analog	Stereo	○	-	-	-	-	ANALOG	-	
EX/ES	Dolby D Surr. EX	Dolby Digital EX	○	○	○	○	○	DD DIGITAL	L, C, R, SL, SR, S, LFE	
	Dolby D (5.1ch)	Dolby Digital EX	○	○	○	○	○	DD DIGITAL	L, C, R, SL, SR, LFE	
	DTS-ES	DTS-ES	○	○	○	○	○	dts , ES	L, C, R, SL, SR, S, LFE	
	DTS(5.1ch)	DTS-ES	○	○	○	○	○	dts	L, C, R, SL, SR, LFE	
DOLBY (PL IIx movie) (PL IIx music) (PL IIx game) (Pro Logic)	Dolby D Surr. EX	Dolby Digital 5.1	○	○	○	○	○	DD DIGITAL	L, C, R, SL, SR, S, LFE	
	Dolby D (5.1ch)	Dolby Digital 5.1	○	○	○	○	○	DD DIGITAL	L, C, R, SL, SR, LFE	
	Dolby D (2ch)	Pro Logic IIx	○	○	○	○	-	DD DIGITAL	L, R	
	Dolby D (2ch Surr)	Pro Logic IIx	○	○	○	○	-	DD DIGITAL , DD SURROUND	L, R, S	
	PCM (Audio)	Pro Logic IIx	○	○	○	○	-	PCM	L, R	
	Analog	Pro Logic IIx	○	○	○	○	-	ANALOG	-	
DTS (Neo:6 Cinema) (Neo:6 Music)	DTS-ES	DTS 5.1	○	○	○	-	○	dts, ES	L, C, R, SL, SR, S, LFE	
	DTS 96/24	DTS 96/24	○	○	○	-	○	dts 96/24	L, C, R, SL, SR, LFE	
	DTS (5.1ch)	DTS 5.1	○	○	○	-	○	dts	L, C, R, SL, SR, LFE	
	PCM (Audio)	Neo:6	○	○	○	○	-	PCM	L, R	
	Analog	Neo:6	○	○	○	○	-	ANALOG	-	
	Dolby D (2ch)	Neo:6	○	○	○	○	-	DD DIGITAL	L, R	
CS II Cinema CS II Music CS II Mono	Dolby D (2ch Surr)	Neo:6	○	○	○	○	-	DD DIGITAL , DD SURROUND	L, R, S	
	PCM (Audio)	CS II	○	○	○	○	○	PCM	L, R	
	Analog	CS II	○	○	○	○	○	ANALOG	-	
	Dolby D (2ch)	CS II	○	○	○	○	○	DD DIGITAL	L, R	
STEREO	Dolby D (2ch Surr)	CS II	○	○	○	○	○	DD DIGITAL , DD SURROUND	L, R, S	
	Dolby Surr. EX	Stereo	○	-	-	-	○	DD DIGITAL	L, C, R, SL, SR, S, LFE	
	Dolby D (5.1ch)	Stereo	○	-	-	-	○	DD DIGITAL	L, C, R, SL, SR, LFE	
	Dolby D (2ch)	Stereo	○	-	-	-	-	DD DIGITAL	L, R	
	Dolby D (2ch Surr)	Stereo	○	-	-	-	-	DD DIGITAL , DD SURROUND	L, R, S	
	DTS-ES	Stereo	○	-	-	-	○	dts, ES	L, C, R, SL, SR, S, LFE	
	DTS 96/24	Stereo	○	-	-	-	○	dts 96/24	L, C, R, SL, SR, LFE	
	DTS (5.1ch)	Stereo	○	-	-	-	○	dts	L, C, R, SL, SR, LFE	
	PCM (Audio)	Stereo	○	-	-	-	-	PCM	L, R	
	PCM 96kHz	Stereo	○	-	-	-	-	PCM	L, R	
	HDCD	PCM (Stereo)	○	-	-	-	-	PCM HDCD	L, R	
Virtual	Analog	Stereo	○	-	-	-	-	ANALOG	-	
	Dolby Surr. EX	Virtual	○	-	-	-	-	DD DIGITAL	L, C, R, SL, SR, S, LFE	
	Dolby D (5.1ch)	Virtual	○	-	-	-	-	DD DIGITAL	L, C, R, SL, SR, LFE	
	Dolby D (2ch)	Virtual	○	-	-	-	-	DD DIGITAL	L, R	
	Dolby D (2ch Surr)	Virtual	○	-	-	-	-	DD DIGITAL , DD SURROUND	L, R, S	
	DTS-ES	Virtual	○	-	-	-	-	dts, ES	L, C, R, SL, SR, S, LFE	
	DTS (5.1ch)	Virtual	○	-	-	-	-	dts	L, C, R, SL, SR, LFE	
	PCM (Audio)	Virtual	○	-	-	-	-	PCM	L, R	
	Analog	Virtual	○	-	-	-	-	ANALOG	-	
	Multi Ch. Stereo	Dolby Surr. EX	Dolby Digital EX	○	○	○	○	○	DD DIGITAL	L, C, R, SL, SR, S, LFE
		Dolby D (5.1ch)	Dolby Digital 5.1	○	○	○	-	○	DD DIGITAL	L, C, R, SL, SR, LFE
Dolby D (2ch)		Multi Channel Stereo	○	○	○	○	-	DD DIGITAL	L, R	
Dolby D (2ch Surr)		Multi Channel Stereo	○	○	○	○	-	DD DIGITAL , DD SURROUND	L, R, S	
DTS-ES		DTS-ES	○	○	○	○	○	dts, ES	L, C, R, SL, SR, S, LFE	
DTS (5.1ch)		DTS 5.1	○	○	○	-	○	dts	L, C, R, SL, SR, LFE	
PCM (Audio)		Multi Channel Stereo	○	○	○	○	-	PCM	L, R	
Analog		Multi Channel Stereo	○	○	○	○	-	ANALOG	-	

Notes:

- Dolby Digital (2 ch: Lt/Rt): signal with Dolby Surround flag Speakers are full set.
- No sound outputs from the surround speaker, center speaker and subwoofer if the DVD disc has no surround data.

Abbreviations

- L/R : Front speakers
- C : Center speaker
- SL/SR : Surround speakers
- SBL/SBR : Surround Back speakers
- SubW : Sub woofer speaker

OTHER FUNCTION

ATTENUATION TO ANALOG INPUT SIGNAL

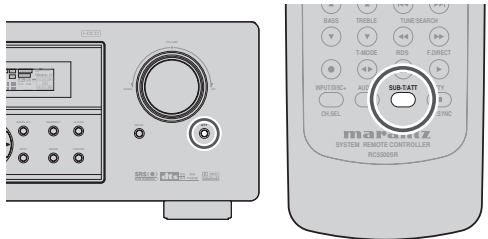

If the selected analog audio input signal is greater than the capable level of internal processing, the "PEAK" indicator will light up on the front display. If this happens, you should press the **ATT** button on the front panel or on the remote. "ATT" indicator will be illuminated when this function is activated. The signal-input level is reduced by about half. Attenuation will not work with the output signal of TAPE-OUT, CD-R/MD-OUT, VCR1-OUT and DSS/VCR2-OUT. This function is memorized for each individual input source.

LISTENING THROUGH HEADPHONES

This jack may be used to listen to the SR3001's output through a pair of headphones. Be certain that the headphones have a standard 1/4" stereo phono plug. (Note that the speakers will automatically be turned off when the headphone jack is in use.)

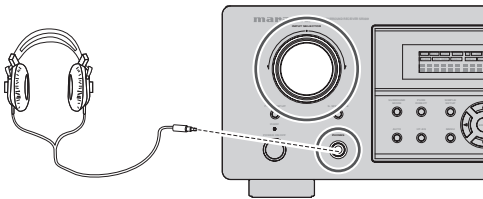

- Notes:**
- When using headphones, the surround mode will change to STEREO and TruSurround (TS) headphones by SURROUND MODE button.
 - The surround mode returns to the previous setting as soon as the plug is removed from the jack.

VIDEO ON/OFF

When no video signal is connected to the SR3001 or a DVD, etc., is connected directly to your TV, the unnecessary video circuit can be turned off by selecting the "VIDEO OFF" setting. To select video off, press the **V-OFF** button on the remote.

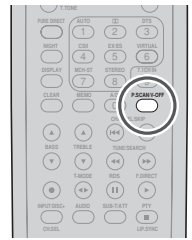

DISPLAY MODE

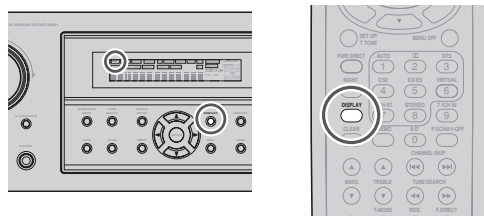

You can select the display mode for the front display of the SR3001. To select this mode, press the **DISPLAY** on the front panel or on the remote. When this button is pressed, the display mode is switched in the following sequence.
 → Surround Mode → Auto-display Off → Display Off → Input Function → Surround Mode...
 In Auto display off mode, the display is off. But, if you make a change to the unit such as input or surround mode, the display will show that change, then go back to off after about 3 seconds. When changing the volume, it is not displayed. In Display off mode, the display is off completely.

- Note:**
- Only the DISP indicator will be illuminated on the front display, in display off condition

SELECTING ANALOG AUDIO INPUT OR DIGITAL AUDIO INPUT



If you have already assigned the digital inputs, you can temporarily select the audio input mode for each input source with the **A/D** button on the remote controller. When this button is pressed, the input mode is switched in the following sequence.
 → Digital Auto → Digital → Analog → Digital Auto...
 In Digital Auto mode, the types of signals being input to the digital and analog input jacks for the selected input source are detected automatically. If no digital signal is being input, the analog input jacks are selected automatically. In Digital mode, input is fixed to an assigned digital input terminal. In analog mode, the analog input jacks are selected. This selecting is temporary, so the result will not be stored in memory. If you need to change the input mode completely, use INPUT setup in SETUP MENU system. (see page 17)

RECORDING AN ANALOG SOURCE

In normal operation, the audio or video source selected for listening through the SR3001 is sent to the record outputs.

This means that any program you are watching or listening to may be recorded simply by placing machines connected to the outputs for **TAPE OUT, CD-R/MD OUT, VCR1 OUT, and DSS/VCR2 OUT** in the record mode.

To record the input source signal you are currently watching or listening to

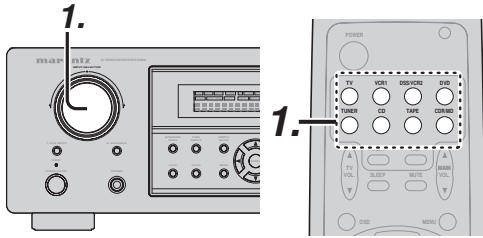

1. Select the input source to record by turning the **INPUT FUNCTION SELECTOR** knob on the front panel or simply press the **input selector** buttons on the remote.
The input source is now selected and you may watch or listen to it as desired.
2. The currently selected input source signal is output to the **TAPE OUT, CD-R/MD OUT, VCR1 OUT, and DSS/VCR2 OUT** outputs for recording.
3. Start recording to the recording component as desired.

Recording the video from one source and the audio from another

You can add the sound from one source to the video of another source to make your own video recordings.

Below is an example of recording the sound from a compact disc player connected to CD IN and the video from a video camera connected to VCR1 to video cassette recorder connected to the DSS/VCR2 OUT jack.

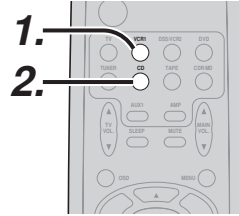

1. Switch the video output source to VCR1 by simply pressing the **input selector** buttons on the remote.
2. Switch the audio input source to CD by simply pressing the **input selector** buttons on the remote.
3. Now "CD" has been selected as the audio input source and "VCR1" as the video input source.

Notes:

- If you change the input source during recording, you will record the signals from the newly selected input source.
- You cannot record the surround effects.
- There is no conversion from digital to analog .

When connecting CD players and other digital components, do not connect only the digital terminals, but the analog ones as well.

HT-EQ

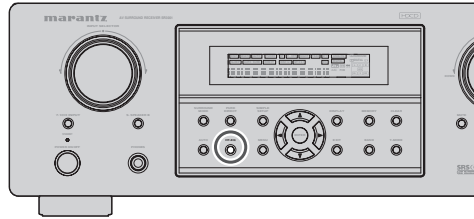

Press the **HT-EQ** button on the front panel to turn on the HT-EQ mode.

The tonal balance of a film soundtrack will be excessively bright and harsh when played back over audio equipment in the home. This is because film soundtracks were designed to be played back in large movie theater environments.

Activating the HT-EQ feature when watching a film made for movie theaters corrects this and restores the correct tonal balance.

The HT-EQ feature can be activated only while in Dolby Pro Logic Mode, or while decoding Dolby Digital or DTS encoded material.

7.1 CH INPUT

The SR3001 is equipped for future expansion through the use of Multi channel SACD multichannel player or DVD-Audio player.

When this is selected, the input signals connected to the L (front left), R (front right), CENTER, SL (surround left), SR (surround right) and SBL (surround back left) and SBR (surround back right) channels of the 7.1 CH. In jacks are output directly to the front (left and right), center, surround (left and right) and surround back speaker systems as well as the pre-out jacks without passing through the surround circuitry.

In addition, the signal input to the SW (subwoofer) jack is output to the PRE OUT SW (subwoofer) jack. When 7.1 CH. INPUT is selected, the last video input used remains routed to the **Monitor Outputs**. This permits simultaneous viewing with video sources

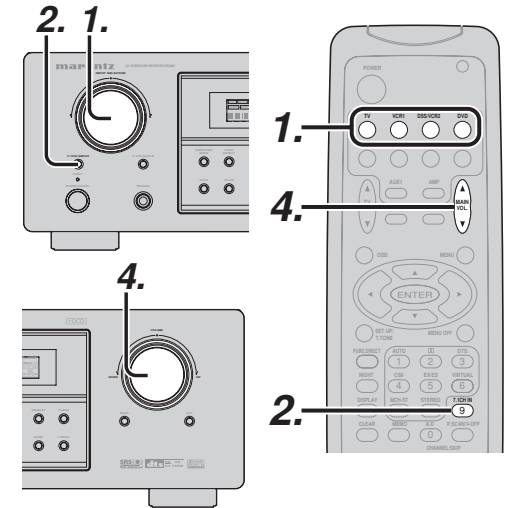

1. Select a desired Video source to decide the routed video signal to the **Monitor Outputs** .
2. Press the **7.1 CH INPUT** button on the front panel or press **7.1 CH IN** on the remote to switch the 7.1 channel input.

- If it is necessary to adjust the output level of each channel, press the **CH.SEL** button on the remote.

Adjust the speaker output levels so that you can hear the same sound level from each speaker at the listening position. For the front left, front right, center, surround left, surround right and surround back speakers, the output levels can be adjusted between -10 to +10 dB.

The subwoofer can be adjusted between -15 and +10 dB.

These adjustments result will be stored to 7.1 CH. INPUT memory.

- Adjust the main volume with the **MAIN VOLUME** knob or the **VOL** buttons on the remote.

To cancel the 7.1 CH. INPUT setting, press the **7.1 CH INPUT** button on the front panel or press **7.1 CH IN** on the remote.

Notes:

- When the 7.1 CH. Input is in use, you may not select a surround mode, as the external decoder determines processing.
- In addition, there is no signal at the record outputs when the 7.1 CH. Input is in use.

7.1 CH INPUT LEVEL

This menu is to adjust the speaker levels for 7.1-channel input sources.

Here you will adjust the volume for each channel so that they are all heard by the listener at the same level.

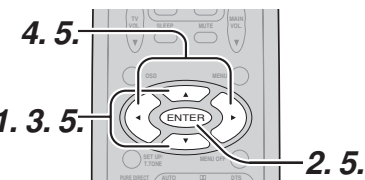
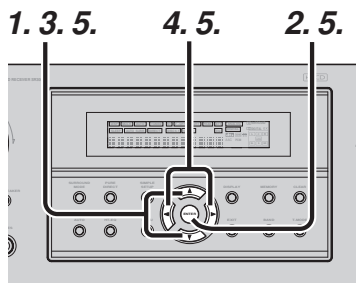

- Press the **CH.SEL** button on the remote to enter this menu.
- Press **▲** or **▼** cursor button to select desired channel.
- Using the **◀** or **▶** cursor button, adjust the volume level of each channel.

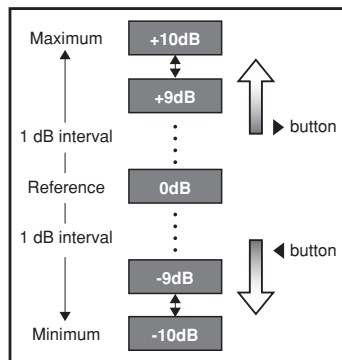

Notes:

- When no operation is taken for 5 seconds, the level setup mode will be cancelled.
- The condition of these setup will be memorized to 7.1CH INPUT source.

MENU STRUCTURE of 7.1CH INPUT LEVEL setup

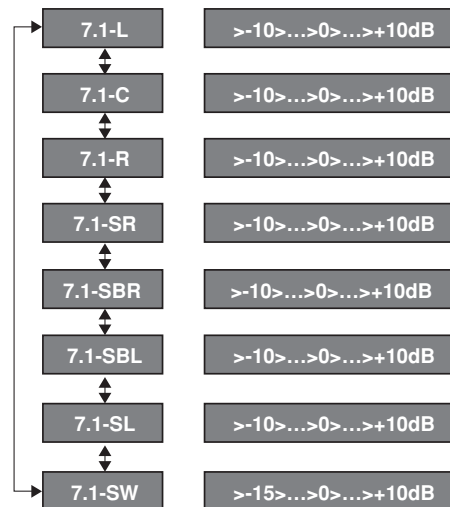

BASIC OPERATION (TUNER)

LISTENING TO THE TUNER

Frequency scan step for AM is selectable. Default setup is 10 kHz step, if your country's standard is 9 kHz step, Press **TUNER** button on the remote more than 6 seconds. Scan step will change.

Note:

Preset memory for the tuner will clear by changing this setup.

AUTO TUNING

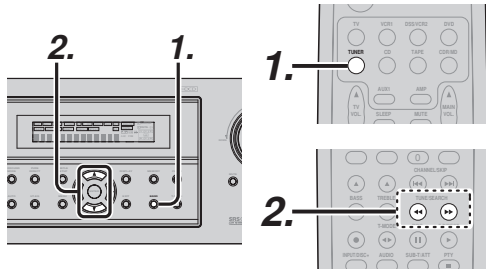

(Using the SR3001)

1. To select tuner and desired band (FM or AM), press the **BAND** button on the front panel.
2. Press the **▲** or **▼** cursor buttons on the front panel for more than 1 second to start the auto tuning function.
3. Automatic searching begins then stops when a station is tuned in.

(Using the remote control unit)

1. To select tuner and desired band (FM or AM), press the **TUNER** button twice within in two seconds on the remote.
2. Press the **◀** or **▶** for more than 1 second on the remote.
3. Automatic searching begins then stops when a station is tuned in.

If tuning does not stop at the desired station, use to the "Manual tuning" operation.

MANUAL TUNING

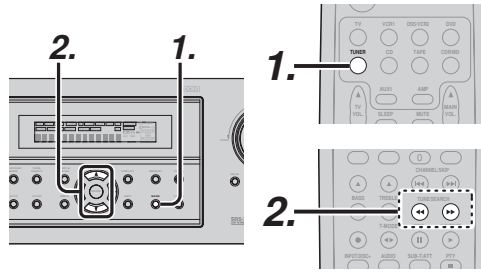

(Using the SR3001)

1. To select tuner and desired band (FM or AM), press the **BAND** button on the front panel
2. Press the **▲** or **▼** cursor buttons on the front panel to select the desired station.

(Using the remote control unit)

1. To select tuner and desired band (FM or AM), press the **TUNER** button twice within in two seconds on the remote.
2. Press the **◀** or **▶** on the remote to tune in the desired station.

DIRECT FREQUENCY CALL

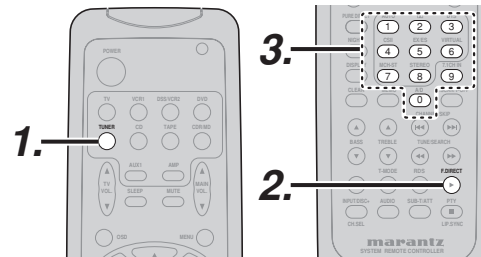

1. To select tuner and desired band (FM or AM), press the **TUNER** button twice within two seconds on the remote.
2. Press the **F.DIRECT** on the remote, display will show "FREQ ----".
3. Input your desired station's frequency with the **numeric** buttons on the remote.
4. The desired station will automatically be tuned.

(FM) TUNING MODE (AUTO STEREO OR MONO)

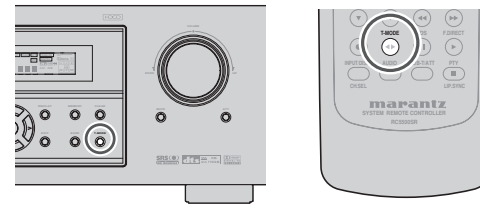

When in the auto stereo mode, **AUTO** indicator will be illuminated on the display. The "ST" indicator is illuminated when a stereo broadcast is tuned in.

At open frequencies, the noise is muted and the "TUNED" and "ST" indicators are not illuminated. If the signal is weak, it may be difficult to tune into the station in stereo. In such a case, press the **T-MODE** button on the front panel or remote.

"AUTO" indicator is not illuminated, if FM stereo broadcasts are received in monaural and the "ST" indicator is not illuminated.

To return to auto stereo mode, press the **T-MODE** button or press **T-MODE** button on the remote again. **AUTO** indicator is illuminated on the display.

PRESET MEMORY

With this unit you can preset up to 50 FM/AM stations in any order.

For each station, you can memorize the frequency and reception mode if desired.

AUTO PRESET MEMORY

This function automatically scans the FM and AM band and enters all stations with proper signal strength into the memory.

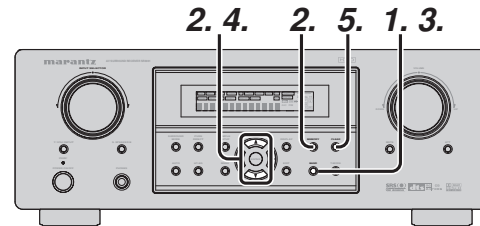

1. To select FM, press the **BAND** button on the front panel.
2. While pressing the **MEMO** button, press the **▶** cursor button.

"AUTO PRESET" will appear on the display, and scanning starts from the lowest frequency.

3. Each time the tuner finds a station, scanning will pause and the station will be played for five seconds.

During this time, the following operations are possible.

The band can be changed by the **BAND** button.

4. If no button is pressed during this period, the current station is memorized in location Preset 02.

If you wish to skip the current station, press the **▲** cursor button during this period, this station is skipped and auto presetting continues.

5. Operation stops automatically when all 50 preset memory positions are filled or when auto scanning attains the highest end of all bands. If you desire to stop the auto preset memory at anytime, press the **CLEAR** button.

MANUAL PRESET MEMORY

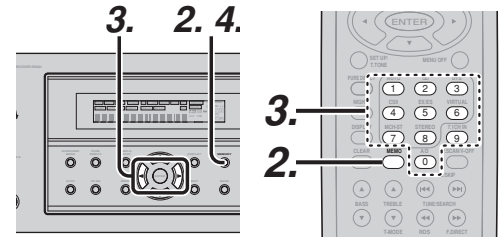

(Using the SR3001)

1. Tune into the radio station you desire (Refer to the "MANUAL TUNING" or "AUTO TUNING" section).
2. Press the **MEMO** button on the front panel. "--" (preset number) starts blinking on the display.
3. Select the preset number by pressing the **▲** or **▼** cursor buttons, while this is still blinking (approx. 5 seconds)
4. Press the **MEMO** button again to enter. The display stops blinking.

The station is now stored in the specified preset memory location.

(Using the remote control unit)

1. Tune into the radio station you desire (Refer to the “MANUAL TUNING” or “AUTO TUNING” section).
2. Press the **MEMO** button on the remote. “--” (preset number) starts blinking on the display.
3. Enter the desired preset number by pressing the **numeric** buttons.

Note:

When entering a single digit number (2 for example), either input “02” or just input “2” and wait for a few seconds.

RECALLING A PRESET STATION

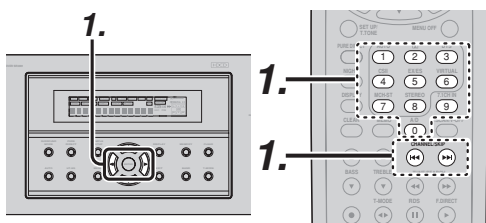

(Using the SR3001)

1. Select the desired preset station by pressing the ◀ or ▶ cursor buttons on the front panel

(Using the remote control unit)

1. Press the ◀◀ or ▶▶ buttons to select the desired preset station, or input your desired preset channel with the **numeric** buttons on the remote.

PRESET SCAN

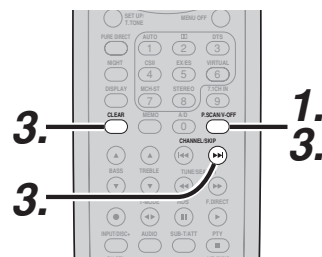

(Using the remote control unit)

1. Press the **P.SCAN** on the remote. “PRESET SCAN” appears on the display and then the preset station with the lowest preset number is recalled first.
2. Preset stations are recalled in sequence (No.1 → No.2 → etc.) for 5 seconds each. No stored preset number will be skipped.
3. You can fast forward the preset stations by pressing the ▶▶ continuously. When the desired preset station is received, cancel the preset scan operation by pressing the **CLEAR** button or **P.SCAN** on the remote.

CLEARING STORED PRESET STATIONS

You can remove preset stations from the memory using the following procedure.

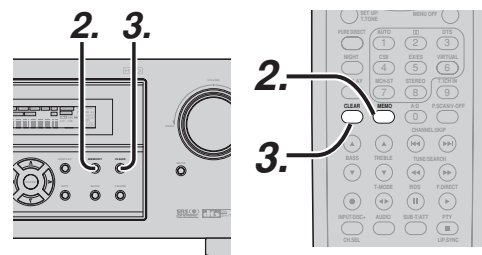

1. Recall the preset number to be cleared with the method described in “Recalling” a preset station.
2. Press the **MEMO** button on the front panel or press the **MEMO** button on the remote.
3. The stored preset number blinks in the display for 5 seconds. While blinking, press the **CLEAR** button on the front panel or the remote.
4. “xx CLEAR” appears on the display to indicate that the specified preset number has been cleared.

Note:

To clear all stored preset stations, press and hold the **CLEAR** and the **ENTER** buttons for two seconds.

SORTING PRESET STATIONS

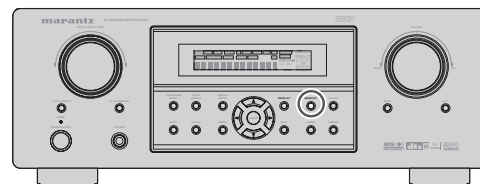

If you have stations memorized, and there is a gap in the sequential order:

i.e. the stations are stored as follows

- 1) 87.1 MHz
- 2) 93.1 MHz
- 3) 94.7 MHz
- 10) 105.9 MHz

(notice there is no stations programmed for pre sets for 4-9), you can have pre set 10 become pre set 5: To sort the numbers, press and hold the **MEMO** and the ▼ cursor buttons.

“PRESET SORT” will appear on the display and sorting will be done.

NAME INPUT OF THE PRESET STATION.

This function allows the name of each preset channel to be entered using alphanumeric characters.

Before name inputting, you need to store preset stations with the preset memory operation.

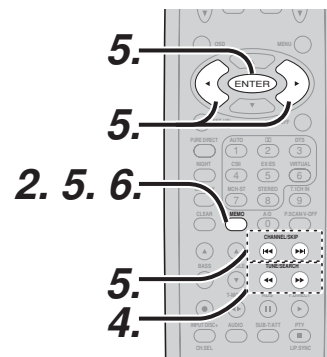
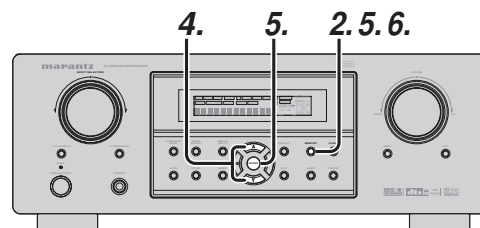

1. Recall the preset number to be inputted name with the method described in “Recalling” a preset station.
2. Press the **MEMO** button on the front panel or press the **MEMO** button on the remote for more than 3 seconds.
3. The left most column of the station name indicator flashes, indicating the character entry ready status.
4. When you press the ▲ or ▼ cursor buttons on the front panel or the ◀◀ / ▶▶ buttons on the remote, alphabetic and numeric characters will be displayed in the following order:
A → B → C ... Z → 1 → 2 → 3 0 → - → + → / → (Blank) → A
UP →
← DOWN
5. After selecting the first character to be entered, press the **MEMO** or **ENTER** buttons, press the **MEMO** button on the remote.

The entry in this column is fixed and the next column starts to flash. Fill the next column the same way.

To move back and forth between the characters, press the ◀ / ▶ cursor buttons or press ◀◀ or ▶▶ buttons on the remote.

Note:

Unused columns should be filled by entering blanks.

6. To save the name, press the **MEMO** button on the front panel or remote for more than 2 seconds.

Ten keypad	Press, press again, press again, etc.
1	A → B → C → 1 → A
2	D → E → F → 2 → D
3	G → H → I → 3 → G
4	J → K → L → 4 → J
5	M → N → O → 5 → M
6	P → Q → R → 6 → P
7	S → T → U → 7 → S
8	V → W → X → 8 → V
9	Y → Z → space → 9 → Y
0	-- → + → / → 0

SURROUND SPEAKER B SYSTEM

The Surround Speaker B system is a function which allows you to listen to the same source in a room other than the room in which the SR3001 is located.

The operations possible with the Surround speaker function are explained briefly below.

ANOTHER ROOM PLAYBACK USING THE S(SURROUND) SPEAKER B TERMINALS

The SR3001 allows you to connect another set of speakers and place them in a another room or separated area for listening to music.

The SURROUND SPEAKER B system can not be operated with the supplied remote controller.

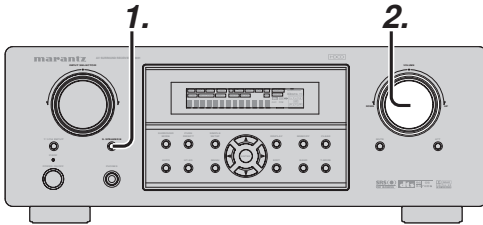

1. Press the **S(Surround) SPEAKER B** button. The unit enters surround speaker B mode and the “**SPKR B**” will appear on the display.
2. The volume of S. SPEAKER B is interlocked with the main volume.

Notes for SURROUND SPEAKER B

- SURROUND SPEAKER B On/ Off is available in main room only.
- SURROUND SPEAKER B output terminals can be used when the SURROUND BACK SPEAKER is set NONE in SPEAKER SETUP menu. (See SPEAKER SETUP, page 18)
- “The Surr. Back Speakers are in use” is displayed by pressing the **S. SPEAKER B** button when the SURROUND BACK SPEAKER is set except NONE in SPEAKER SETUP menu. (See SPEAKER SETUP, page 18)
- Surround Speaker B function is unavailable, while the unit is 7.1 CH input mode.

TROUBLESHOOTING

In case of trouble, check the following before calling for service:

1. Are the connections made properly ?
2. Are you operating the unit properly following the user's guide ?
3. Are the power amplifiers and speaker working properly ?

If the unit does not operate properly, check items shown in the following table.

If your trouble cannot be recovered with the remedy actions listed in the following table, malfunction of the internal circuitry is suspected; immediately unplug the power cable and contact your dealer, nearest Marantz authorized dealer or the Marantz Service Center in your country.

SYMPTOM	CAUSE	REMEDY
SR3001 cannot be turned up.	The power plug is not connected.	Connect the power plug to the outlet.
No sound and picture are output even when power is on.	Mute is on.	Cancel mute using the remote control unit.
	The input cable is not connected correctly.	See the connection diagram and connect the cables correctly.
	The master volume control is turned all the way down.	Adjust the master volume.
	The function selector position is wrong.	Select correct position.
No speaker output.	The headphones are connected to the headphone jack.	Disconnect the headphones. (Speakers will not output sound when headphones are connected.)
Incorrect Audio or Video for selected source.	Input cable connected incorrectly.	Connect the cable correctly by referring to the connection diagram.
Incorrect Audio from a channel.	Speaker cable connected incorrectly.	Connect the cable correctly by referring to the connection diagram.
No Audio output from the center channel speaker.	The center speaker cable connection is incomplete.	Connect the cable correctly.
	STEREO has been selected for Surround mode.	When STEREO is selected for Surround mode, no sound will be output from the center speaker. Set another Surround mode.
	Center = NONE has been selected in SETUP mode.	Make the correct setting.
No Audio output from the surround speakers.	The surround speaker cable connection is incomplete.	Connect the cable correctly.
	STEREO has been selected for Surround mode.	When STEREO has been selected for Surround mode, no sound will be output from the surround speaker. Set another Surround mode.
	Surround = NONE has been selected in SETUP mode.	Make the correct setting.
No Audio output from the surround back speakers.	The surround back speaker cable connection is incomplete.	Connect the cable correctly.
	Surround mode is not EX/ES mode.	Set surround mode EX/ES.
	Surround back = NONE has been selected in SPEAKERS SIZE SETUP	Make the correct setting.

SYMPTOM	CAUSE	REMEDY
Can not select EX/ES mode.	Surround center= NONE has been selected in SPEAKERS SIZE SETUP	Make the correct setting.
	Input signal is incompatible.	Use 5.1channel source.
Can not select Pro Logic IIx mode.	Input signal is incompatible.	Use 2 channel Dolby Digital input signal, PCM input signal or analog input signal.
Can not select Neo:6 mode.	Input signal is incompatible.	Use 2 channel Dolby Digital input signal, PCM input signal or analog input signal.
Can not select CSII mode.	Input signal is incompatible.	Use 2 channel Dolby Digital input signal, PCM input signal or analog input signal.
No output to Sub Woofer Out.	Sub-woofer = NONE has been selected in SETUP mode.	Select Sub-woofer = YES.
Noise is produced during DTS-encoded CD or laser disc play.	Analog has been selected for input.	Be sure to perform digital connection, select digital input, then play.
A specific channel does not produce output.	Nothing recorded on source.	Check the encoded channel on the source side.
FM or AM reception fails.	Antenna connection is incomplete.	Correctly connect the indoor FM and AM antennas to FM and AM antenna outlets.
Noise is heard during AM reception.	Reception is affected by other electrical fields.	Try changing location where the AM indoor antenna is set up.
Noise is heard during FM reception.	The radio waves from the broadcasting station are weak.	Install an FM outdoor antenna.
Cannot get programmed station when the PRESET button is pressed.	Preset data has been erased.	Disconnecting power plug for long periods of time will erase preset data. If that happens, input the preset data again.
Control with the remote control unit fails.	Batteries are consumed.	Replace all the batteries with new ones.
	Remote controller's function-key setting is wrong.	Select different position from which equipment will be controlled.
	The distance between this SR3001 and the remote commander is too far.	Move closer to this SR3001.
	Something is blocking SR3001 and the remote commander.	Remove offending object.

GENERAL MALFUNCTION

If the equipment malfunctions, this may be because an electrostatic discharge or AC line interference has corrupted the information in the equipment memory circuits. Therefore:

- disconnect the plug from the AC line supply
- after waiting at least three minutes, reconnect the plug to the AC line supply
- re-attempt to operate the equipment

Memory backup

- In case a power outage occurs or the power cord is accidentally unplugged, the SR3001 is equipped with a backup function to prevent memory data such as the preset memory from being erased.

HOW TO RESET THE UNIT

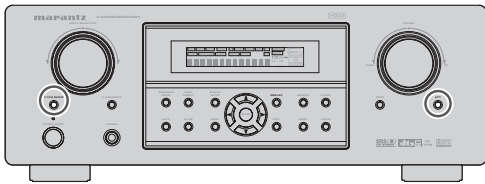

Should the operation or display seem to be abnormal, reset the unit with the following procedure. The SR3001 is turned on, press and hold the **7.1CH INPUT** and **ATT** buttons simultaneously for 3 seconds or more. Remember that the procedure will reset the settings of the function selector, Surround mode, delay time, TUNER PRESET etc., to their initial settings.

TECHNICAL SPECIFICATIONS

FM TUNER SECTION

Frequency Range 87.5 - 108.0 MHz
 Usable Sensitivity IHF 1.8 µV/16.4 dB
 Signal to Noise Ratio Mono/Stereo 75/70 dB
 Distortion..... Mono/Stereo 0.2/0.3 %
 Stereo Separation..... 1 kHz 45 dB
 Alternate Channel Selectivity..... ± 300 kHz 60 dB
 Image Rejection..... 98 MHz 70 dB
 Tuner Output Level 1 kHz, ± 75 kHz Dev 800 mV

AM TUNER SECTION

Frequency Range 520 - 1710 kHz
 Signal to Noise Ratio 50 dB
 Usable Sensitivity Loop 400mV/m
 Distortion..... 400Hz, 30 % Mod. 0.5 %
 Selectivity..... ± 18 kHz 70 dB

AUDIO SECTION

Power Output (20 Hz - 20 kHz/THD=0.08%)
 Front L&R 8 ohms 60 W / Ch
 Center..... 8 ohms 60 W / Ch
 Surround L&R..... 8 ohms 60 W / Ch
 Surround Back L&R..... 8 ohms 60 W / Ch

Front L&R 6 ohms 75 W / Ch
 Center..... 6 ohms 75 W / Ch
 Surround L&R..... 6 ohms 75 W / Ch
 Surround Back L&R..... 6 ohms 75 W / Ch

Input Sensitivity/Impedance 168 mV/ 47 Kohms
 Signal to Noise Ratio(Analog Input / Pure Direct) 105 dB
 Frequency Response
 (Analog Input / Pure Direct)
 8 Hz - 100 kHz (± 3 dB)
 (Digital Input / 96 kHz PCM)
 8 Hz - 45 kHz (± 3 dB)

VIDEO

Television Format.....NTSC
 Input Level/Impedance 1 Vp-p/75 ohms
 Output Level/Impedance..... 1 Vp-p/75 ohms
 Video Frequency Response 5 Hz to 8 MHz (- 1 dB)
 Video Frequency (Component) 5 Hz to 80 MHz (- 1 dB)
 S/N..... 60 dB

GENERAL

Power Requirement.....AC 120 V 60 Hz
 Power Consumption 3.5 A
 Weight 24.5 lbs (11.1 Kg)

ACCESSORIES

- Remote Control Unit RC5500SR 1
- AAA-size batteries 2
- FM Antenna 1
- AM Loop Antenna 1

Specifications subject to change without prior notice.

DIMENSIONS

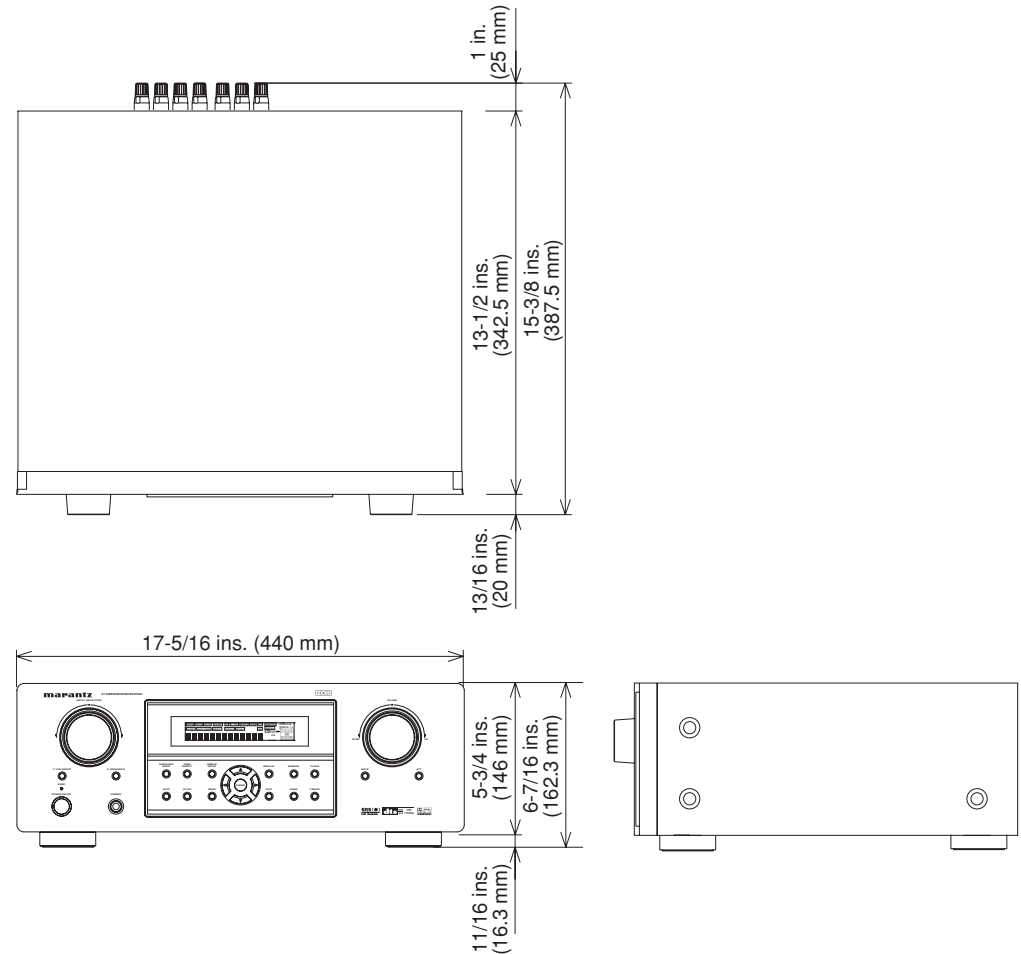

SETUP CODES

CD

Aiwa.....	0184
Burmester.....	0447
California Audio Labs.....	0056
Carver.....	0184, 0206
Classic.....	0324
Denon.....	0030
DKK.....	0027
DMX Electronics.....	0184
Emerson.....	0332
Fisher.....	0352, 0206
Garrard.....	0447
Genexxa.....	0059, 0332
GPX.....	0323
Harman/Kardon.....	0184, 0200, 0229
Hitachi.....	0059
Integra.....	0128
JVC.....	0099, 0321
Kenwood.....	0055, 0064, 0217
KLH.....	0345
Koss.....	0344
Krell.....	0184
Linn.....	0184
Luxman.....	0120
LXI.....	0332
Magnavox.....	0184, 0332
Marantz.....	0999, 0056, 0184
MCS.....	0056
Miro.....	0027
Mission.....	0184
MTC.....	0447
NSM.....	0184
Onkyo.....	0128
Optimus.....	0027, 0059, 0064, 0332, 0206, 0495, 0172, 0447, 0102
Panasonic.....	0056
Parasound.....	0447
Philips.....	0999, 0184
Pioneer.....	0059, 0332, 0495
Polk Audio.....	0184
Proton.....	0184
QED.....	0184
Quad.....	0184

Quasar.....	0056
RadioShack.....	0102
RCA.....	0089, 0059, 0447, 0080, 0332, 0206, 0495
Realistic.....	0447, 0206
Rotel.....	0184, 0447
SAE.....	0184
Sansui.....	0184, 0332
Sanyo.....	0206
Scott.....	0332
Sears.....	0332
Sharp.....	0064
Sonic Frontiers.....	0184
Sony.....	0027, 0127, 0391
Soundesign.....	0172
Symphonic.....	0332
TAG McLaren.....	0184
Tascam.....	0447
TDK.....	0235
Teac.....	0447
Technics.....	0056
Victor.....	0099
Wards.....	0184, 0080
Yamaha.....	0063, 0319
Zonda.....	0184

CDR

Classic.....	0324
Fisher.....	0352
Harman/Kardon.....	0229
JVC.....	0321
Kenwood.....	0999
Marantz.....	0999
Philips.....	0999
Pioneer.....	0089, 0114
Sony.....	0391, 0127
TDK.....	0235
Teac.....	0447
Yamaha.....	0319

MD PLAYERS

Denon.....	1900
Kenwood.....	1708, 1853
Marantz.....	1207
Onkyo.....	1895

Optimus.....	1090
Pioneer.....	1090
Sharp.....	1888
Sherwood.....	1094
Sony.....	1517
Yamaha.....	1915

TAPE

Aiwa.....	0056, 0227, 0224
Akai.....	0310
Carver.....	0056
Denon.....	0103
Fisher.....	0101
Garrard.....	0466, 0335
Harman/Kardon.....	0209, 0056
JVC.....	0271, 0300
Kenwood.....	0097
Magnavox.....	0056
Marantz.....	0056, 0036
Mitsubishi.....	0310
NAD.....	0171
Onkyo.....	0309, 0163, 0162
Optimus.....	0054, 0247, 0466, 0364
Panasonic.....	0256
Philips.....	0056
Pioneer.....	0054, 0247, 0126
Polk Audio.....	0056
RCA.....	0054, 0247
Revox.....	0217
Sansui.....	0056, 0036
Sherwood.....	0364
Sony.....	0270, 0197, 0318
Teac.....	0335
Technics.....	0256
Victor.....	0300
Wards.....	0054
Yamaha.....	0124, 0121

SAT (DSS)

AlphaStar.....	0799
Chaparral.....	0243
Crossdigital.....	1136
DirecTV.....	0419, 0593, 0666, 1666, 1169, 0274, 0776, 1776, 0751, 0846, 1883, 1103,

Dish Network System.....	1032, 0802, 1197
Dishpro.....	1032, 0802
Echostar.....	1032, 0802, 1197
Expressvu.....	0802
GE.....	0593
General Instrument.....	0896
GOI.....	0802
Hitachi.....	0846
HTS.....	0802
Hughes Network Systems.....	1169, 0776, 1776, 1470, 1469
JVC.....	0802, 1197
Magnavox.....	0751, 0749
Memorex.....	0751
Mitsubishi.....	0776
Motorola.....	0896
Next Level.....	0896
Panasonic.....	0274, 0728
Paysat.....	0751
Philips.....	1169, 0776, 1776, 0751, 1103, 0749, 0126, 1469
Proscan.....	0419, 0593
RadioShack.....	0896
RCA.....	0419, 0593, 0882, 0170
Samsung.....	1303, 1136
SKY.....	0883
Sony.....	0666, 1666
Star Choice.....	0896
Tivo.....	1169, 1470, 1469
Toshiba.....	0776, 1776, 0817, 1312
Uniden.....	0751, 0749
Zenith.....	0883, 1883

TV

Admiral.....	0120, 0490
Advent.....	0788, 0869
Aiko.....	0119
Akai.....	0729, 0057, 0699
Albatron.....	0870
America Action.....	0207
Anam.....	0207
AOC.....	0057
Apex Digital.....	0775, 0792, 0906
Audiovox.....	0478, 0207, 0119
Bell & Howell.....	0181
Bradford.....	0207

Broksonic.....	0263, 0490	KEC.....	0207	Sanyo.....	0181	Broksonic.....	0211, 0148, 0236, 1506
Candle.....	0057	Kenwood.....	0057	Scotch.....	0205	Calix.....	0064
Carnivale.....	0057	KLH.....	0792	Scott.....	0263, 0207, 0205	Canon.....	0062
Carver.....	0081	KTV.....	0207, 0057	Sears.....	0074, 0081, 0181, 0183, 0205, 0198	Carver.....	0108
Celebrity.....	0027	LG.....	1205, 0883, 0469	Sharp.....	0120	Citizen.....	0064, 1305
Celera.....	0792	LXI.....	0074, 0081, 0181, 0183, 0205	Sheng Chia.....	0120	Craig.....	0064, 0074, 0267
Changhong.....	0792	Magnavox.....	0081, 0057, 1481, 0733, 1281	Sony.....	0027	Curtis Mathes.....	0087, 0062, 0189, 1062
Citizen.....	0087, 0057, 0119	Marantz.....	0081, 0057, 1581, 0731	Soundesign.....	0207, 0205	Cybernex.....	0267
Clarion.....	0207	Matsushita.....	0277, 0677	Squareview.....	0198	Daewoo.....	0072, 1305
Contec.....	0207	Megatron.....	0205, 0172	SSS.....	0207	Denon.....	0069
Craig.....	0207	Memorex.....	0181, 0490, 0177, 0205	Starlite.....	0207	Durabrand.....	0066
Crosley.....	0081	MGA.....	0177, 0057, 0205	Studio Experience.....	0870	Dynatech.....	0027
Crown.....	0207	Midland.....	0074, 0044, 0078	Supreme.....	0027	Electrohome.....	0064
Curtis Mathes.....	0074, 0081, 0181, 0478, 0120, 0087, 0729, 0057, 0172, 0193, 1174, 1374	Mitsubishi.....	0120, 0177, 1277, 0205, 0863	SVA.....	0775, 0892	Electrophonic.....	0064
CXC.....	0207	Monivision.....	0870	Sylvania.....	0081, 0057, 0198	Emerex.....	0059
Daewoo.....	0478, 1688, 0119, 0699	Motorola.....	0120	Symphonic.....	0207, 0198	Emerson.....	0064, 0211, 0027, 0148, 0070, 0236, 1305, 1506
Denon.....	0172	MTC.....	0087, 0057	Tandy.....	0120	Fisher.....	0074, 0131
Dumont.....	0044	Multitech.....	0207	Tatung.....	1783	Fuji.....	0062, 0060
Durabrand.....	0207, 0205	NAD.....	0183, 0205	Technics.....	0277, 0078	Funai.....	0027
Electroband.....	0027	NEC.....	0057, 1731	Techwood.....	0078	Garrard.....	0027
Elektra.....	0044, 1688	Nikko.....	0057, 0205, 0119	Teknika.....	0081, 0207, 0177, 0087, 0119	GE.....	0087, 0062, 0267, 1087, 1062, 0834
Emerson.....	0181, 0263, 0490, 0207, 0205, 0198	Norcent.....	0775, 0851	Telefunken.....	0729	GoldStar.....	0064, 1264
Envision.....	0057	NTC.....	0119	TMK.....	0205	Gradiente.....	0027
Fisher.....	0181	Onwa.....	0207	TNCi.....	0044	Harley Davidson.....	0027
Fujitsu.....	0710, 0880, 0836	Optimus.....	0181, 0277, 0193, 0677	Toshiba.....	0181, 0183, 0087, 1283, 1383, 1183, 1731, 0677	Harman/Kardon.....	0108
Funai.....	0207, 0198	Optonica.....	0120	TVS.....	0490	Hi-Q.....	0074
Futuretech.....	0207	Orion.....	0263, 0490	Vector Research.....	0057	Hitachi.....	0027, 0069
Gateway.....	1782, 1783	Panasonic.....	0277, 0078, 0677	Victor.....	0080	Hughes Network Systems.....	0069
GE.....	0074, 0078, 0478, 0205, 1474, 1374, 1174	Penney.....	0074, 0183, 0078, 0087, 0057, 0205, 1374	Vidikron.....	0081	JVC.....	0094
Gibraltar.....	0044, 0057	Philco.....	0081, 0057	Vidtech.....	0205	KEC.....	0064
GoldStar.....	0057, 0205	Philips.....	0081, 1481, 0717	Viewsonic.....	1782	Kenwood.....	0094
Grunpy.....	0207	Pilot.....	0057	Wards.....	0081, 0057, 0205, 1183	Kodak.....	0062, 0064
Hallmark.....	0205	Pioneer.....	0193, 0706	Waycon.....	0183	Lloyd's.....	0027
Harman/Kardon.....	0081	Portland.....	0119	White Westinghouse.....	0490	LXI.....	0064
Harvard.....	0207	Prima.....	0788	Yamaha.....	0057	Magnasonic.....	1305
Havermy.....	0120	Prism.....	0078	Zenith.....	0044, 0490, 0205, 0119	Magnavox.....	0062, 0066, 0108, 0027, 1808
Hello Kitty.....	0478	Proscan.....	0074, 1474, 1374			Magnin.....	0267
Himitsu.....	0207	Proton.....	0205			Marantz.....	0062, 0108, 1408
Hisense.....	0775	Pulsar.....	0044			Marta.....	0064
Hitachi.....	1172, 0172	Quasar.....	0277, 0078, 0677			Matsushita.....	0062, 0189
Infinity.....	0081	RadioShack.....	0074, 0181, 0207, 0057, 0205			MEI.....	0062
Inteq.....	0044	RCA.....	0074, 1474, 1274, 1574, 0117, 1174, 1074, 1374, 0706			Memorex.....	0062, 0189, 0064, 0075, 0066, 0074, 0267, 0027, 0131, 0236, 1264
JBL.....	0081	Realistic.....	0181, 0207, 0057, 0205			MGA.....	0267, 0070
JCB.....	0027	Runco.....	0044, 0057			MGN Technology.....	0267
Jensen.....	0788	Sampo.....	0057, 1782			Minolta.....	0069
JVC.....	0080	Samsung.....	0087, 0729, 0057, 0205			Mitsubishi.....	0094, 0070, 0834
		Sansui.....	0490			Motorola.....	0062, 0075

VCR

Admiral.....	0075, 0236
Adventura.....	0027
Aiwa.....	0064, 0027
American High.....	0062
Asha.....	0267
Audiovox.....	0064
Beaumarck.....	0267
Bell & Howell.....	0131

MTC..... 0267, 0027
Multitech 0027
NAD 0085
NEC 0131, 0094
Nikko..... 0064
Noblex 0267
Olympus 0062
Optimus 1089, 0189, 0064,
0075, 0131, 0085
Orion..... 0211, 0236, 1506
Panasonic..... 1089, 0062, 0189,
0252, 1062, 0643
Penney 0062, 0064, 0267,
0069, 1264, 1062
Pentax 0069
Philco..... 0062
Philips..... 0062, 0108, 0645
Pilot..... 0064
Pioneer 0094, 0085
Polk Audio..... 0108
Profitronic 0267
Proscan 0087, 1087
Pulsar 0066
Quasar..... 0062, 0189, 1062
RadioShack 0027
Radix 0064
Randex 0064
RCA 0087, 0267, 0069, 1062,
0907, 0085, 0834, 1087
Realistic 0062, 0064, 0075,
0074, 0027, 0131
ReplayTV..... 0643
Runco 0066
Samsung 0267, 0072, 1041
Sanky..... 0075, 0066
Sansui..... 0027, 0094, 0236, 1506
Sanyo 0074, 0267, 0131
Scott 0211, 0072, 0148, 0070
Sears 0062, 0064, 0074, 0027,
0069, 0131, 1264
Sharp..... 0075, 0834
Shogun..... 0267
Sonic Blue 0643
Sony 0062, 0059, 0060, 0027, 1259, 0663
STS..... 0069
Sylvania..... 0062, 0108, 0027, 0070, 1808
Symphonic..... 0027
Teac 0027
Technics..... 0062, 0189
Teknika 0062, 0064, 0027
Thomas..... 0027

Tivo..... 1530, 0663, 0645
TMK..... 0267
Toshiba 0072, 0070, 1530, 1172, 0872
Totevision..... 0064, 0267
Unitech 0267
Vector 0072
Video Concepts 0072
Videomagic..... 0064
Videosonic..... 0267
Villain 0027
Wards 0087, 0062, 0075, 0074,
0108, 0267, 0027, 0069
White Westinghouse..... 0236
XR-1000 0062, 0027
Zenith..... 0066, 0060, 0027, 0236, 1506

DVD

Aiwa..... 0668
Allegro 0896
Apex Digital 0699, 0823, 1031, 1127,
0821, 0857, 1088, 0824, 1047
Blue Parade..... 0598
Broksonic..... 0722
CineVision 0903, 0896
Curtis Mathes 1114
CyberHome 1050, 0843, 1051
Daewoo 0896, 0860
Denon..... 0517
DVD2000 0548
Emerson 0618, 0848
Enterprise 0618
GE 0549, 0842
Go Video..... 0860, 0742, 0896
Harman/Kardon 0729, 0609
Hitachi..... 0600
Hiteker 0699
JBL 0729
JVC..... 0585, 0650, 0894
Kenwood..... 0517, 0561
KLH..... 1047
Koss..... 0678
Magnavox 0530, 0848
Marantz..... 0566
Memorex..... 0722
Microsoft..... 0549
Mintek 0866
Mitsubishi..... 1548, 0548
Onkyo 0530
Oritron..... 0678

Panasonic..... 0517, 1789, 1389
Philips 0530, 0566, 0673, 0881
Pioneer 0552, 0598
Polaroid 1088
Polk Audio..... 0566
Proscan 0549
Qwestar 0678
RCA 0549, 0598, 0849, 1049
Rio 0896
Rotel 0650
Sampo 0779
Samsung 0517, 0600, 0847
Sansui..... 0722
Sanyo 0722
Sharp 0657, 0779
Shinsonic..... 0560, 0866
Sonic Blue 0896
Sony 0560, 0891, 1060
Superscan 0848
Sylvania..... 0848
Technics..... 0517
Theta Digital 0598
Toshiba 0530, 1072, 0722
Tredex 0826
Urban Concepts..... 0530
US Logic..... 0866
Xbox 0549
Yamaha 0517, 0566, 0572
Zenith..... 0530, 0618, 0896

www.marantz.com

You can find your nearest authorized distributor or dealer on our website.

marantz[®] is a registered trademark.

